

如有变更恕不另行通知，以实物为准。
Assembly to be matched are subject to change without notice. Please confirm with real products.



专注于全自动包装解决方案，产品已广泛
应用于食品，农产品，工业用品，日用品
等领域。

CONTACT US

中国·佛山

佛山市揽德包装机械有限公司

地址：佛山市南海区罗村新光源产业基地C7栋
电话：0757-81807872 传真：0757-81807758
网址：www.landpack.cn 邮箱：yang@landpacking.com
邮编：528226

FOSHAN LAND PACKAGING MACHINERY CO.,LTD

Add : Building C7 of New Lighting Source Industrial Base.
Luocun,Nanhai District,Foshan City,GD,China
Tel : +86 0757-81807872 Fax : +86 0757-81807758
Https://www.landpack.com E-mail : yang@landpacking.com
Zip Code : 528226

LANDPACK



佛山市揽德包装机械有限公司

FOSHAN LAND PACKAGING MACHINERY CO.,LTD

包装袋型：三边封、四边封、三角袋、背封袋、插脚袋、四边烫、五边烫、立式拉链袋、异形袋、连包等



企业简介

揽德包装机械有限公司坐落于广东省佛山市，以其优越的地理位置和良好的市场口碑，赢得广大客户的支持。公司销售网络辐射全国各地，远销全球30多个国家和地区。

本公司是研发、制造和销售各种液体灌装机、颗粒灌装机、粉末灌装机、封口机、封尾机和贴标机等相关设备,并提供全自动包装生产线整线设计和整体解决方案的现代化包装设备企业。

公司通过ISO9001质量管理体系认证,相关设备通过CE、SGS等认证。配备有丰富经验的研发、制造工程师队伍和专业的销售服务团队,确保您用合理的成本,获得性能稳定,外观卓越和人性化程度高的设备和优质满意的服务体验。

设备广泛适用于食品、中药材、饮料和农产品等相关行业的产品包装和各种制罐厂的生产中。

揽德包装机作为国内先进包装设备制造厂商,致力于为企业 提供包装整体解决方案,令企业所需包装的过程得到质的提升,最大限度地解放了劳动力,避免了二次污染,以高效的方式提高企业的生产率。

LANDPACKAGING MACHINERY CO., LTD. IS LOCATED IN FOSHAN CITY, GUANGDONG PROVINCE. WITH ITS SUPERIOR GEOGRAPHICAL LOCATION AND GOOD MARKET REPUTATION, IT HAS WON THE SUPPORT OF CUSTOMERS. THE COMPANY'S SALES NETWORK RADIATES ALL OVER THE COUNTRY AND IS EXPORTED TO MORE THAN 30 COUNTRIES AND REGIONS AROUND THE WORLD.

THE COMPANY IS A MODERN PACKAGING EQUIPMENT ENTERPRISE WHICH DEVELOPS, MANUFACTURES AND SELLS ALL KINDS OF LIQUID FILLING MACHINES, PARTICLE FILLING MACHINES, POWDER FILLING MACHINES, SEALING MACHINES, TAIL SEALING MACHINES AND LABELING MACHINES, AND PROVIDES FULL-AUTOMATIC PACKAGING PRODUCTION LINE DESIGN AND OVERALL SOLUTIONS.

THE COMPANY HAS PASSED ISO 9001 QUALITY MANAGEMENT SYSTEM CERTIFICATION, AND RELEVANT EQUIPMENT HAS PASSED CE AND SGS CERTIFICATION. EQUIPPED WITH A TEAM OF EXPERIENCED R & D AND MANUFACTURING ENGINEERS AND A PROFESSIONAL SALES AND SERVICE TEAM, YOU CAN GET STABLE PERFORMANCE, EXCELLENT APPEARANCE AND HIGH DEGREE OF HUMANIZATION EQUIPMENT AND HIGH QUALITY AND SATISFACTORY SERVICE EXPERIENCE AT REASONABLE COST.

THE EQUIPMENT IS WIDELY USED IN FOOD, CHINESE HERBAL MEDICINE, BEVERAGE, AGRICULTURAL PRODUCTS AND OTHER RELATED INDUSTRIES OF PRODUCT PACKAGING AND VARIOUS CANNERY PRODUCTION.

企业形象

★ 公司实力



★ 资质证书



CE 认证

ISO 认证

SGS 认证

TUV 认证

专利证书



高新技术企业认证



营业执照



LD 系列立式包装机

Automatic packaging machine

LD-420/520

- LD-420A/LD-520A
组合秤量全自动配套体系
Fully automatic packaging system with multi-heads weigher
- LD-420B/LD-520B
链斗式半自动配套体系
Semi-automatic packaging system with chain-type volumetric batchers
- LD-420C/LD-520C
容积式全自动配套体系
Fully automatic packaging system with volumetric cups
- LD-420D/LD-520D
螺杆计量式自动配套体系
Powder automatic packaging machine



(一) 选配装置

- 双拉膜机构, 插角机构, 自动纠偏机构, 打孔装置, 连袋装置。

(二) 主要性能和结构特点

- 全新设计, 亮丽外观, 结构更合理, 技术更先进。
- 中文或英文显示(可根据客户要求设置语言)。
- 进口PLC全电脑控制系统, 彩色触摸屏, 可清晰显示工作状态及运行指示灯, 操作方便, 直观高效。
- 不停机可直接在触摸屏上调整封切位置, 纠偏等。
- 进口伺服运膜系统, 进口色标传感器, 定位准确, 整机性能优越, 包装美观。
- 配合横纹齿型封口, 包装更加牢固;还可以选用直纹、网纹等。
- 多种自动报警保护功能, 最大限度减低损耗。
- 袋形多样化, 可为客户提供枕形袋、插角袋、挂孔袋、连袋等。

(三) 适用范围

- 适用于各类膨化食品、糖果、花生、种子、爆米花等颗粒状、条状、片状物料和奶粉、洗衣粉、淀粉等粉状物料的自动化包装。

(四) 技术规格 Specifications

机 型 (Type)	LD-420	LD-520
薄膜宽度 (Film width)	Max.420mm	Max.520mm
制袋长度 (Bag length)	80-300mm	60-400mm
制袋宽度 (Bag width)	60-200mm	100-250mm
卷膜直径 (Film roll diameter)	Max.600mm	Max.600mm
包装速度 (Packing speed)	5-60bag/min	5-40bag/min
计量范围 (Measuring range)	1000ml	2000ml
薄膜厚度 (Film thickness)	0.04-0.12mm	0.04-0.12mm
电源规格 (Power Supply)	220V,50/60Hz,3KW	220V,50/60Hz,3KW
机器尺寸 (Machine size(L*W*H))	(L)1217X(W)1015X(H)1343mm	(L)1488X(W)1080X(H)1490mm
机器质量 (Machine weight)	About 650kg	About 680kg
包装材质 (Film material)	BOPP/CPP, BOPP/VMCPP, BOPP/PE, PET/VMPET/PE, PET/AL/PE, PET/PET ETC.	

封口形式
Type of bag

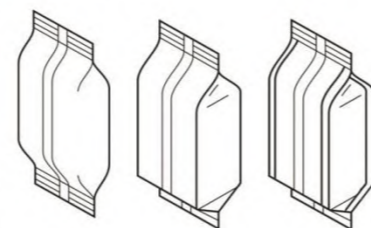

Option

- Two synchronous belt device, gusset device, automatic rectifying device hole-punching device, link bag device.

Feature

- New design with perfect fashion, more reasonable structure, more advanced technology.
- Chinese or English display (Language can be set according to customer requirements).
- Imported PLC control system, colorful touch screen, can clearly shows working state and operation indicator,easy to operate,intuitionistic and efficient.
- Can adjust the cutting position and correct the deviation directly on the touch screen in the working state.
- Accurate positioning with imported servo film transporting system and color mark sensor, superexcellent capability for complete machine, perfect packaging.
- With transverse teeth sealing,packaging is more solid;also can choose straight grain,mesh grain,etc.
- With auto warning protection function to minimize loss.
- Various kinds of bag, it could provide the pillow bag, gusseted bag, hang hole bag, link bag, etc.

Applications

- Suitable for automatic packaging of various kinds of puffed food, candies, peanuts, seeds and such materials in grain or piece as well as powder like milk powder, washing powder, starch, etc.

LD 系列立式包装机

Automatic packaging machine

LD-620/720

- LD-620A/720A
组合秤量全自动配套体系
Fully automatic packaging system with multi-heads weigher
- LD-620B/720B
链斗式半自动配套体系
Semi-automatic packaging system with chain-type volumetric batchers
- LD-620C/720C
容积式全自动配套体系
Fully automatic packaging system with volumetric cups
- LD-620D/720D
螺杆计量式自动配套体系
Powder automatic packaging machine



(一) 选配装置

- 真空拉膜结构, 插角结构, 托料装置, 打孔装置, 连袋装置。

(二) 主要性能和结构特点

- 全新设计, 亮丽外观, 结构更合理, 技术更先进。
- 中文或英文显示(可根据客户要求设置语言)。
- 进口PLC全电脑控制系统, 彩色触摸屏, 可清晰显示工作状态及运行指示灯, 操作方便, 直观高效。
- 进口伺服运膜系统, 进口色标传感器, 定位准确, 整机性能优越, 包装美观。
- 配合横纹齿型封口, 包装更加牢固;还可以选用直纹、网纹等。
- 多种自动报警保护功能, 最大限度减低损耗。
- 袋形多样化, 可为客户提供枕形袋、插角袋、挂孔袋、连袋等。
- 自动纠偏功能, 省时、省力、省膜, 操作更具智能化。
- 采用外置式放膜结构, 包装膜安装更简单、更快捷。

(三) 适用范围

- 适用于各类膨化食品、糖果、花生、种子、爆米花等颗粒状、条状、片状物料和奶粉、洗衣粉、淀粉等粉状物料的自动化包装。

(四) 技术规格 Specifications

机 型 (Type)	LD-620	LD-720
薄膜宽度 (Film width)	150-Max.620mm	150-Max.720mm
制袋长度 (Bag length)	60-450mm	60-500mm
制袋宽度 (Bag width)	65-300mm	65-350mm
卷膜直径 (Film roll diameter)	Max.600mm	Max.600mm
包装速度 (Packing speed)	5-35bag/min	5-30bag/min
计量范围 (Measuring range)	3000ml	5000ml
薄膜厚度 (Film thickness)	0.04-0.12mm	0.04-0.12mm
电源规格 (Power Supply)	220V,50/60Hz,3.2KW	220V,50/60Hz,3.5KW
机器尺寸 (Machine size(L*W*H))	(L)1488X(W)1180X(H)1550mm	(L)1780X(W)1350X(H)2050mm
机器质量 (Machine weight)	About 700kg	About 750kg
包装材质 (Film material)	BOPP/CPP, BOPP/VMCPP, BOPP/PE, PET/VMPET/PE, PET/AL/PE, PET/PET ETC.	

封口形式
Type of bag

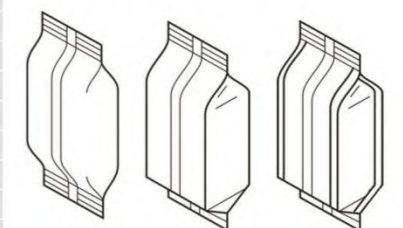

Option

- Vacuum film feeding device, angle fold device, retainer devices hole-punching device, link bag devic

Feature

- New design with perfect fashion, more reasonable structure, more advanced technology.
- Chinese or English display (Language can be set according to customer requirements).
- Imported PLC control system, colorful touch screen, can clearly shows working state and operation indicator,easy to operate,intuitionistic and efficient.
- Accurate positioning with imported servo film transporting system and color mark sensor, superexcellent capability for complete machine, perfect packaging.
- With transverse teeth sealing,packaging is more solid;also can choose straight grain,mesh grain,etc.
- With auto warning protection function to minimize loss.
- Various kinds of bag, it could provide the pillow bag, gusseted bag, hang hole bag, link bag, etc.
- Automatic correct function, save time, labor, and film, the operation more intelligent.
- Adopt external film feeding mechanism. Film setting be more easy and quick.

Applications

- Suitable for automatic packaging of various kinds of puffed food, candies, peanuts, seeds and such materials in grain or piece as well as powder like milk powder, washing powder, starch, etc.

LD 系列立式包装机

Automatic packaging machine

LD-900/1200

- LD-900A/LD-1200A
组合秤量全自动配套体系
Fully automatic packaging system with multi-heads weigher
- LD-900C/LD-1200C
容积式全自动配套体系
Fully automatic packaging system with volumetric cups
- LD-900D/LD-1200D
螺杆计量式自动配套体系
Powder automatic packaging machine



(一) 选配装置

- 双伺服结构, 真空拉膜结构, 打孔装置, 连袋装置。

(二) 主要性能和结构特点

- 全新设计, 亮丽外观, 结构更合理, 技术更先进。
- 中文或英文显示(可根据客户要求设置语言)。
- 进口PLC全电脑控制系统, 彩色触摸屏, 可清晰显示工作状态及运行指示灯, 操作方便, 直观高效。
- 进口伺服运膜系统, 进口色标传感器, 定位准确, 整机性能优越, 包装美观。
- 多种自动报警保护功能, 最大限度减低损耗。
- 配有双运膜结构, 插角机构和托料装置, 功能更完善。
- 袋形多样化, 可为客户提供挂孔袋、连袋等。
- 自动纠偏功能, 省时、省力、省膜, 操作更具智能化。
- 采用气胀轴夹膜机构, 包装膜安装更简单、更快捷。

(三) 适用范围

- 适用于各类膨化食品、糖果、花生、种子、爆米花等颗粒状、条状、片状物料和奶粉、洗衣粉、淀粉等粉状物料的自动化包装。

(四) 技术规格 Specifications

机 型 (Type)	LD-900	LD-1200
薄膜宽度 (Film width)	Max.900mm	Max.1200mm
制袋长度 (Bag length)	100-700mm	100-1000mm
制袋宽度 (Bag width)	260-430mm	290-580mm
卷膜直径 (Film roll diameter)	Max.600mm	Max.600mm
包装速度 (Packing speed)	5-20bag/min	5-20bag/min
计量范围 (Measuring range)	10L	20L
薄膜厚度 (Film thickness)	0.04-0.12mm	0.04-0.12mm
电源规格 (Power Supply)	220V, 50/60Hz, 4.5KW	220V, 50/60Hz, 5KW
机器尺寸 (Machine size(L*W*H))	(L)2305X(W)1685X(H)2725mm	(L)2900X(W)2050X(H)3500mm
包装材质 (Film material)	BOPP/CPP, BOPP/VMP, BOPP/PE, PET/VMPET/PE, PET/AL/PE, PET/PET ETC.	

封口形式
Type of bag

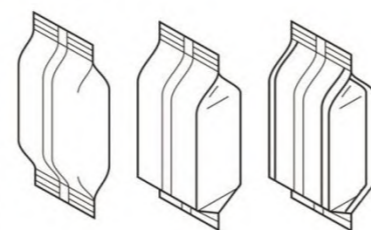

Option

- Double-servo devices, vacuum film feeding hole-punching device, link bag device.

Feature

- New design with perfect fashion, more reasonable structure, more advanced technology.
- Chinese or English display (Language can be set according to customer requirements).
- Imported PLC control system, colorful touch screen, can clearly shows working state and operation indicator, easy to operate, intuitionistic and efficient.
- Accurate positioning with imported servo film transporting system and color mark sensor, superexcellent capability for complete machine, perfect packaging.
- With auto warning protection function to minimize loss.
- With double transporting devices, gusset devices and retainer devices, function more perfect.
- Various kinds of bag, it could provide the hang hole bag, link bag, etc.
- Automatic correct function, save time, labor, and film, the operation more intelligent.
- Adopt gas-pressure shaft clamping film structure Film setting be more easy and quick.

Applications

- Suitable for automatic packaging of various kinds of puffed food, candies, peanuts, seeds and such materials in grain or piece as well as powder like milk powder, washing powder, starch, etc.

LD 系列四边烫包装主机

Quad seal bag packaging machine

LDB-420/520/720

- LD-420A/LD-520A/720A
组合秤量全自动配套体系
Fully automatic packaging system with multi-heads weigher
- LD-420B/LD-520B/720B
链斗式半自动配套体系
Semi-automatic packaging system with chain-type volumetric batchers
- LD-420C/LD-520C/720C
容积式全自动配套体系
Fully automatic packaging system with volumetric cups
- LD-420D/LD-520D/720D
螺杆计量式自动配套体系
Powder automatic packaging machine



(一) 选配装置

- 双伺服结构, 真空拉膜结构, 打孔装置, 连袋装置。

(二) 主要性能和结构特点

- 全新设计, 亮丽外观, 结构更合理, 技术更先进。
- 中文或英文显示(可根据客户要求设置语言)。
- 纵封采用四边烫封形式, 袋样美观, 成型稳定。
- 进口PLC全电脑控制系统, 彩色触摸屏, 可清晰显示工作状态及运行指示灯, 操作方便, 直观高效。
- 进口伺服运膜系统, 进口色标传感器, 定位准确, 整机性能优越, 包装美观。
- 多种自动报警保护功能, 最大限度减低损耗。
- 配有双运膜结构, 插角机构和托料装置, 功能更完善。
- 袋形多样化, 可为客户提供挂孔袋、连袋等。
- 自动纠偏功能, 省时、省力、省膜, 操作更具智能化。
- 采用外置式放膜机构, 包装膜安装更简单、更快捷。

(三) 适用范围

- 适用于各类膨化食品、糖果、花生、种子、爆米花等颗粒状、条状、片状物料和奶粉、洗衣粉、淀粉等粉状物料的自动化包装。

(四) 技术规格 Specifications

机 型 (Type)	LDB-420	LDB-520	LDB-720
薄膜宽度 (Film width)	150-Max.420mm	250-Max.520mm	260-Max.720mm
制袋长度 (Bag length)	80-300mm	60-400mm	65-550mm
制袋正面宽度 (Bag for Width)	64-145mm	65-175mm	65-170mm
制袋侧面宽度 (Bag for Width)	45-80mm	45-110mm	45-140mm
纵封宽度 (Longitudinal sealing Width)	5-10mm		
包装速度 (Packing speed)	8-25bags/min		
计量范围 (Measuring range)	1000ml	1500ml	8000ml
薄膜厚度 (Film thickness)	0.04-0.08mm		
电源规格 (Power Supply)	220V 50Hz 2.8KW	220V 50Hz 3.2KW	220V 50/60Hz 3.5KW
机器尺寸 (Machine size(L*W*H))	(L)1390X(W)1155X(H)800mm	(L)1492X(W)1255X(H)2184mm	(L)1590X(W)1500X(H)2408mm
机器质量 (Machine weight)	about 600KG	about 700KG	about 800KG

Option

- Double-servo devices, vacuum film feeding hole-punching device, link bag device.

Feature

- New design with perfect fashion, more reasonable structure, more advanced technology.
- Chinese or English display (Language can be set according to customer requirements).
- Longitudinal sealing is used by four sides with hot sealing type, bag is more beautiful and shape stabilization.
- Imported PLC control system, colorful touch screen, can clearly shows working state and operation indicator, easy to operate, intuitionistic and efficient.
- Accurate positioning with imported servo film transporting system and color mark sensor, superexcellent capability for complete machine, perfect packaging.
- With auto warning protection function to minimize loss.
- With double transporting devices, gusseting devices and retainer devices, function more perfect.
- Various kinds of bag, it could provide the hang hole bag, link bag, etc.
- Automatic correct function, save time, labor, and film, the operation more intelligent.
- Adopt external film feeding mechanism. Film setting be more easy and quick.

Applications

- Suitable for automatic packaging of various kinds of puffed food, candies, peanuts, seeds and such materials in grain or piece as well as powder like milk powder, washing powder, starch, etc.

LD 系列全自动集中供料包装解决方案

Automatic packaging solutions for grain foods

LD-420A/520A/620A/720A

(一) 机械说明

- 此集中供料方案适用于同类物量大的包装，整套结构紧凑，占地小。
- 集中供料大量节约设备购置维修成本、人力操作成本。水平快退输送物料，输送量大且均匀，不易碎料，设备运行噪音小，安静，耐用。

(二) 机械组成

- | | |
|------------|------------|
| 1. LD系列主机 | 4. 多头组合电子秤 |
| 2. Z型物料输送机 | 5. 支撑平台 |
| 3. 成品输送机 | |

(三) 主要性能和结构特点

- 中文或英文显示(可根据客户要求设置语言)。
- 整套设备联动控制，自动控制供料、无料不包装，设备运行稳定，损耗低。
- 实现全自动化自动输送、计量、填充制袋、真空、打印日期、成品输出等全部过程。
- LD系列包装机是最早期的成熟机型，十多年来国内及出口销量最大。
- 物料输送机设计简洁、运行平稳，安静。
- 平台从设计到用料的合理，使其平稳安全，让组合秤的精准测量不受影响。
- 前可连接生产线，成品可直接重检，金属探测机可对其进行检测。后可接入纸盒包装线，形成整套流水包装方案，大量节约成本。

(四) 适用范围

- 适合要求计量精度高及易碎的散状物体的包装，如：膨化食品、锅巴、果冻、糖果、开心果、苹果片、水饺、汤圆、朱古力、小五金件、药材等。



Instructions

- This packaging solution is suitable for large production packaging .
- Economical, save costs, small footprint. Horizontal rewind conveying the material, with large transportation.

Option

- | | |
|------------------------------|------------------------------------|
| 1. LD series main frame | 4. Multi-heads combination weigher |
| 2. Z type bucket elevator | 5. Support platform |
| 3. Finished product conveyor | |

Feature

- Chinese or English display(Language can be set according to customer requirements).
- Complete set of equipment control, automatic control of feeding, packaging without material, stable operation of equipment and low loss.
- The machine complete the whole process of automatic feeding, measuring, filling, bag making, vacuum, date printing and finished product output automatically.
- LD series packaging machine is the earliest mature machine, and has the largest sales volume in domestic and export in more than ten years.
- Material conveyor design is simple, smooth and quiet.
- From the design to the rational use of materials, the platform is stable and safe, so that the accurate measurement of the combined scale will not be affected.
- The product can be connected before the production line, the finished product can be rechecked directly, the metal inspecting machine can test it. Then the carton packaging line can be connected to form a complete package line, which saves a lot of cost.

Applications

- It's suitable to use in packaging the high accuracy and easy fragile mate ria such as: puffy food, crispy rice, jelly, candy, pistachio, apple slices, dumpling, chocolate, pet food, small hardwares. Medicine, etc.

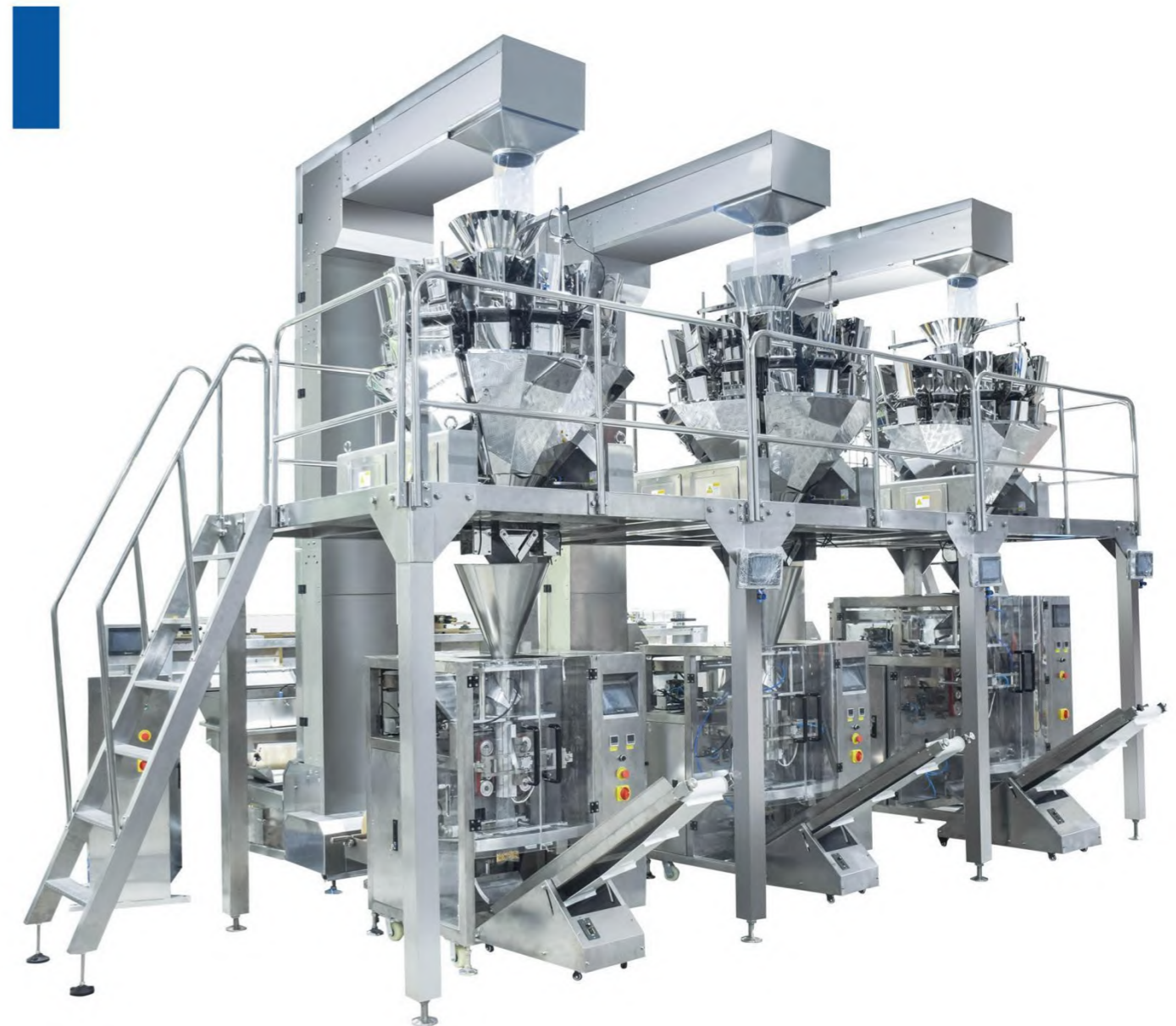

(五) 技术规格 Specifications

机 型 (Type)	LD-420	LD-520	LD-620	LD-720
薄膜宽度 (Film width)	Max.420mm	Max.520mm	150-Max.620mm	150-Max.720mm
制袋长度 (Bag length)	80-300mm	60-400mm	60-450mm	60-500mm
制袋宽度 (Bag width)	60-200mm	100-250mm	65-300mm	65-350mm
卷膜直径 (Film roll diameter)	Max.600mm	Max.600mm	Max.600mm	Max.600mm
包装速度 (Packing speed)	5-60bag/min	5-40bag/min	5-35bag/min	5-30bag/min
制袋体积 (Making-bag volume)	1000ml	2000ml	3000ml	5000ml
薄膜厚度 (Film thickness)	0.04-0.12mm	0.04-0.12mm	0.04-0.12mm	0.04-0.12mm
电源规格 (Power Supply)	220V,50/60Hz,3KW	220V,50/60Hz,3KW	220V,50/60Hz,3.2KW	220V,50/60Hz,3.5KW
机器尺寸 (Machine size)	(L)1217X(W)1015X(H)1343mm	(L)1488X(W)1080X(H)1490mm	(L)1488X(W)1180X(H)1550mm	(L)1780X(W)1350X(H)2050mm

LD 系列组合称量带选别秤及金属探测仪全自动配套体系

Full automatic packaging machine with select and detector combined with computer combination weigher

LD-420A/520A/620A/720A



(一) 机械组成

- | | |
|------------|---------------|
| 1. LD系列主机 | 6. 十头或多头电脑组合秤 |
| 2. Z型物料输送机 | 7. 振动送料机 |
| 3. 支撑平台 | 8. 成品输送机 |
| 4. 选别秤 | 9. 金属检测仪 |
| 5. 圆盘理料机 | |

(二) 主要性能和结构特点

- 中文或英文显示(可根据客户要求设置语言)。
- 全自动化完成送料、计量、充填制袋、打印日期、成品输出。
- 自动选别所需重量的产品并将不合格重量的产品剔除、自动检测金属并报警解除、多工位包装的全过程。
- 高自动化操作，真正体现自动包装的合理性。
- 计量精准、效率高、不碎料。

(三) 适用范围

- 适合要求计量精度高及易碎的散状物体的包装，如：膨化食品、锅巴、果冻、糖果、开心果、苹果片、水饺、汤圆、朱古力、小五金件、药材等。

Option

- | | |
|-------------------------------|--|
| 1. LD series main frame | 6. Multi-heads combined electronic scale |
| 2. Z type bucket elevator | 7. Vibration feeder |
| 3. Supporting platform | 8. Finished product conveyor |
| 4. Weight Selection Scale | 9. Metal detector |
| 5. Disk transportation feeder | |

Feature

- Chinese or English display(Language can be set according to customer requirements).
- The machine complete the whole procedure of feeding, measure ring, bagging, date printing, charging(exhausting), product out-putting.
- Also can select the required weight of the products and will remove the weight of product what is substandard, detect metal and will alarm removed, multiple-stage packaging process automatically.
- Highly automated operation, truly reflect the rationality of the automated packaging.
- High precision, high efficiency without crash the materials.

Applications

- It's suitable to use in packaging the high accuracy and easy fragile materials such as: puffy food, crispy rice, jelly, candy, pistachio, apple slices, dumpling, chocolate, pet food, small hardware. Medicine, etc

LD 系列组合称量全自动配套体系

Full automatic packaging machine combined with computer combination weigher

LD-420A/520A/620A/720A



(一) 机械组成

- | | |
|------------|------------|
| 1. LD系列主机 | 3. 成品输送机 |
| 2. Z型物料输送机 | 4. 十头电脑组合秤 |

(二) 主要性能和结构特点

- 中文或英文显示(可根据客户要求设置语言)。
- 整套设备联动控制，自动控制供料、无料不包装，设备运行稳定，损耗低。
- LD系列包装机应用了伺服拉膜系统，机械设计简洁，易操作，易维修。物美价廉是其最大的特点。
- LD系列包装机是最早期的成熟机型，十多年来国内及出口销量最大。
- 物料输送机设计简洁、运行平稳，安静。
- 平台从设计到用料的合理，使其平稳安全，让组合秤的精准测量不受影响。
- 前可连接生产线，成品可直接重检，金属检测机可对其进行检测。后可接装盒等二次包装、生产线，形成整套流水包装方案，大量节约成本。

(三) 适用范围

- 适合要求计量精度高及易碎的散状物体的包装，如：膨化食品、锅巴、果冻、糖果、开心果、苹果片、水饺、汤圆、朱古力、小五金件、药材等。

Option

- | | |
|----------------------|---------------------------------|
| 1. LD series machine | 3. Finished product conveyor |
| 2. Z type conveyor | 4. 10 heads combination weigher |

Feature

- Chinese or English display(Language can be set according to customer requirements).
- This machine is linkage control, automatic feeding, no packaging without materials, work stable.
- This machine had applied the servo film pulling system, advanced design, easy to operate & maintain, the price is competitive.
- LD series packaging machine is the earliest mature machine, and this machine is both domestic & foreign best seller in the past 10 years.
- Material conveyor design simplicity, work stable and quite.
- The platform is sold will not affect the measurement accuracy of the combination weigher.

Applications

- It's suitable to use in packaging the high accuracy and easy fragile materials such as: puffy food, crispy rice, jelly, candy, pistachio, apple slices, dumpling, chocolate, pet food, small hardware. Medicine, etc.

LD 系列4斗线性秤包装机

Series 4 head linear scale packaging machine

LD-420AS/520AS/620AS/720AS

(一) 机械组成

- | | |
|------------|----------|
| 1. LD系列主机 | 3. 成品输送机 |
| 2. Z型物料输送机 | 4. 线性电子秤 |

(二) 主要性能和结构特点

- 中文或英文显示(可根据客户要求设置语言)。
- 进口PLC全电脑控制系统, 彩色触摸屏, 可清晰显示工作状态及运行指示灯, 操作方便, 直观高效。
- 全新高集称模块化控制系统。
- 振幅自动调节功能, 调试更方便。
- 可以同时称量多种不同物料, 实现混合物料包装。
- 根据生产情况可在运行中直接修改参数, 操作简便。
- 采用无级振机加料系统, 使物料更均匀, 称重范围更大。全部采用不锈钢材料, 清洁卫生。
- 带有气动开门装置, 可实现自动关闭加料振机。
- 与物料接触部件(储料斗、下料斗、振动盘、称量斗等)均可实现快速拆卸, 清洗尤为方便。

(三) 适用范围

- 适合白糖、盐、种子、大米、芝麻、味精、鸡精、奶粉、咖啡、调味粉等粉状、小颗粒状较为均匀物料的定量称量。

(四) 技术规格 Specifications

机 型 (Type)	LD-420	LD-520	LD-620	LD-720
薄膜宽度 (Film width)	Max.420mm	Max.520mm	150-Max.620mm	150-Max.720mm
制袋长度 (Bag length)	80-300mm	60-400mm	60-450mm	60-500mm
制袋宽度 (Bag width)	60-200mm	100-250mm	65-300mm	65-350mm
卷膜直径 (Film roll diameter)	Max.600mm	Max.600mm	Max.600mm	Max.600mm
包装速度 (Packing speed)	5-60bag/min	5-40bag/min	5-35bag/min	5-30bag/min
制袋体积 (Making-bag volume)	1000ml	2000ml	3000ml	5000ml
薄膜厚度 (Film thickness)	0.04-0.12mm	0.04-0.12mm	0.04-0.12mm	0.04-0.12mm
电源规格 (Power Supply)	220V,50/60Hz,3KW	220V,50/60Hz,3KW	220V,50/60Hz,3.2KW	220V,50/60Hz,3.5KW
机器尺寸 (Machine size)	(L)1217X(W)1015X(H)1343mm	(L)1488X(W)1080X(H)1490mm	(L)1488X(W)1180X(H)1550mm	(L)1780X(W)1350X(H)2050mm
备 注 (Remarks)	可加充气装置 (Optional air filling device)/有插角装置(Optional angle folding device)			
包装材质 (Film material)	BOPP/CPP, BOPP/VMCPP, BOPP/PE, PET/VMPET/PE, PET/AL/PE, PET/PET ETC.			

Option

- | | |
|----------------------|------------------------------|
| 1. LD series machine | 3. Finished product conveyor |
| 2. Z type conveyor | 4. Linear Electronic Scale |

Feature

- Chinese or English display(Language can be set according to customer requirements).
- Imported PLC control system, colorful touch screen, can clearly shows working state and operation indicator,easy to operate,intuitionistic and efficient.
- New high set according to modular control system.
- Amplitude of automatic adjustment function, debugging more convenient.
- Can weigh a variety of different materials at the same time, the realization of mixed material package.
- According to the production situation can directly modify the parameters in the running, easy operation.
- Adopts stepless vibration machine feed system, make the material more evenly, weighing range greater all adopt the stainless steel materials, clean health.
- With a pneumatic door opener, and can realize the vibration feeding machine will be automatically closed.
- And material contact parts (storage hopper, hopper, vibration plate, weighing hopper, etc.) are to realize fast disassembly, particularly convenient clean.

Applications

- It is suitable for weighing white sugar, salt, seeds, rice, sesame, monosodium glutamate, chicken essence, milk powder, coffee, seasoning powder powdery and small granular materials.

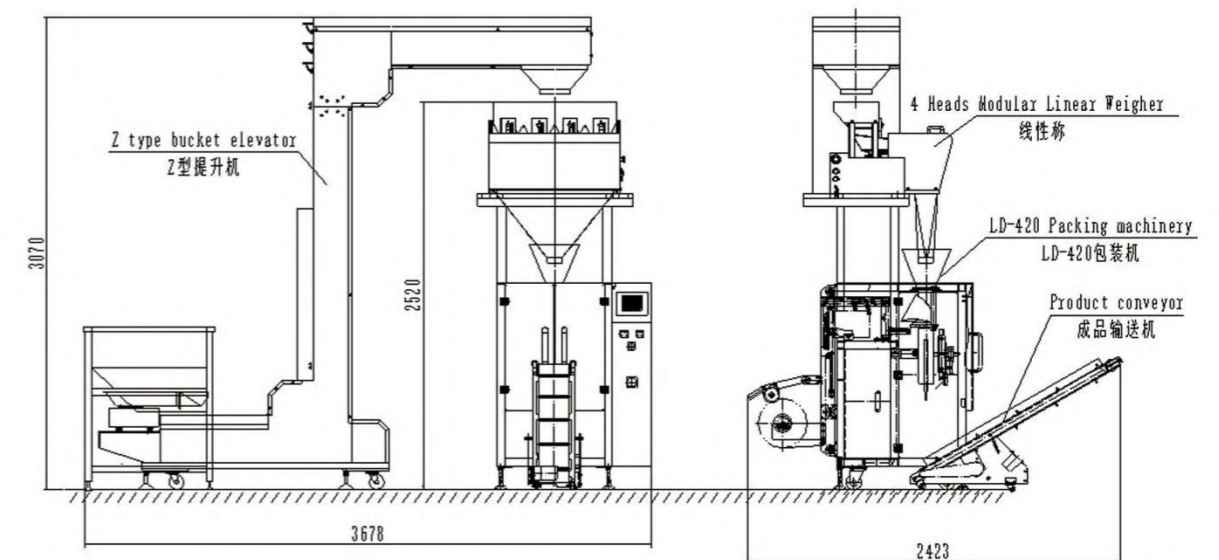

LD 系列容积式全自动配套量杯

Full automatic packaging machine combined with volumetric cups

LD-420C/520C/620C/720C



封口形式
Type of bag

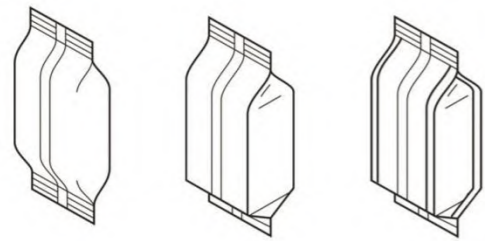

(一) 机械组成

- 必选 LD系列主机 量杯计量装置
- 备选 物料提升机 成品输送机

Option

- Necessary LD series main frame Measuring cups device
- Option Material elevator Product conveyor

(二) 主要性能和结构特点

- 中文或英文显示(可根据客户要求设置语言)。
- 进口PLC控制系统, 彩色触摸屏, 可清晰显示工作状态及运行指示灯, 操作方便, 直观高效。
- 自动完成产品输送、计量、充填制袋、打印日期、成品输出的全部自动过程。
- 整套配置经济实惠。
- 可根据物料要求改装成开合门式计量装置, 效率高, 不碎料。
- 量杯式计量装置是容积充填法中的一种, 是通过容积来测量充填物料的数量。该设备结构简单、充填速度快、适用性强、使用成本低、符合食品药品卫生标准等特点。

Feature

- Chinese or English display(Language can be set according to customer requirements).
- Imported PLC control system, colorful touch screen, can clearly shows working state and operation indicator,easy to operate,intuitionistic and efficient.
- It completes the whole procedure of feeding, metering, bagging, date printing,charging(exhausting), product out-putting automatically
- A complete set of equipment is economical.
- The volumetric cups can be make to open-close model measure equipment.
- The measuring device of measuring cup is one of the characteristics of volumetric filling method,which is measuring the quantity of filling material by volume.The equipment is simple in structure,quick in filling speed,strong in applicability , low in cost and in accordance with the hygienic standard of food and medicine,and so on.

Applications

- Bulk grain, slice, short bar material products such as puffy food, chip rice, sunflower seed, seed, peanut.

(三) 适用范围

- 适合膨化、虾条、大米、瓜子、种子、花生等散状颗粒、块状、短条状、球状物料。

LD 系列组合称量全自动配套体系

Full automatic packaging machine with computer combination weigher

LD-420Y/520Y/620Y/720Y

封口形式
Type of bag

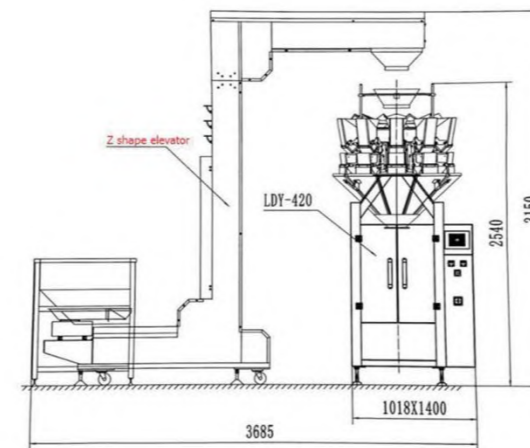

(一) 机械组成

- 双拉膜机构, 插角机构, 自动纠偏机构, 打孔装置, 连袋装置。

Option

- Two synchronous belt device, angle fold device, automatic rectifying device hole-punching device, link bag device.

(二) 主要性能和结构特点

- 中文或英文显示(可根据客户要求设置语言)。
- 全新设计, 亮丽外观, 结构更合理, 技术更先进。
- 进口PLC全电脑控制系统, 彩色触摸屏, 可清晰显示工作状态及运行指示灯, 操作方便, 直观高效。
- 进口伺服运膜系统, 进口色标传感器, 定位准确, 整机性能优越, 包装美观。
- 多种自动报警保护功能, 最大限度减低损耗。
- 袋形多样化, 可为客户提供枕形袋, 插角袋, 挂孔袋, 连袋等。

Feature

- Chinese or English display(Language can be set according to customer requirements).
- New design with perfect fashion, more reasonable structure, more advanced technology.
- Imported PLC control system, colorful touch screen, can clearly shows working state and operation indicator,easy to operate,intuitionistic and efficient.
- Accurate positioning with imported servo film transporting system and color mark sensor, superexcellent capability for complete machine, perfect packaging.
- With auto warning protection function to minimize loss.
- Various kinds of bag, it could provide the pillow bag, gusseted bag, hang hole bag, link bag, etc.

(三) 适用范围

- 应用于包装精度高和容易脆性材料, 如: 豆类、茶、糖、盐、新鲜水果和干果、薯片、膨化食品、大米、开心果、巧克力、宠物食品、小硬件、洗衣粉等。

Applications

- Applied to packaging the high accuracy and easy fragile material, such as:Beans, tea, sugar, salt, fresh and dried fruit, potato chips, puffed food, rice, candy, pistachio, dumpling, chocolate, pet food, small hardware, detergent powder etc.

LD 系列粉剂称量全自动配套体系

Automatic powder packaging machine

LD-420D/520D/620D/720D

(一) 机械组成

1. LD系列主机
2. 螺杆提升机
3. 螺杆计量机
4. 成品输送机

Option

1. LD packaging machine
2. Screw conveyor
3. Auger metering machine
4. Finished Product Conveyor

(二) 主要性能和结构特点

- 中文或英文显示(可根据客户要求设置语言)。
- 采用螺杆计量机完成计量、填充等,适用于计量粉状物料。
- 采用伺服驱动系统,具有精度高、性能稳定等优点。
- 不锈钢开启式料箱,清洁方便。
- 配备安全防护,符合企业安全管理要求。
- 采用智能温控,温度控制准确,保证封口美观平整。
- 采用PLC双拉或单拉膜结构走纸系统,封切位置采用电机自动纠偏装置。
- 超大显示触摸屏构成驱动控制核心,最大限度提高了整机的控制精度、可靠性和智能化程度。
- 本机与计量配置可自动完成计量、送料、充填制袋、充气(排气)、日期打印的全部包装过程,并自动完成计数。
- 完善的自动报警器保护功能,将损耗降到最低,帮助及时排除故障。
- 包装的款式多样化,背封,插角,连袋,冲孔等。

Feature

- Chinese or English display(Language can be set according to customer requirements).
- By screw machine complete measuring, filling, etc., suitable for measuring powder material.
- The servo drive system, has the advantages of high precision, stable performance.
- Stainless steel open container clean and convenient.
- Equipped with safety protection so as to meet the requirements of enterprise safety management.
- Intelligent temperature control, accurate temperature control, ensure nice flat seal.
- PLC double pull or single tensile membrane structure chart system, motor sealing and cutting positions adopt automatic correction device.
- Constitute a large display touch screen drive control core, maximum limit to improve the control precision, reliability and the intellectualized degree of the machine.
- The machine and measuring configuration can be done automatically measuring, feeding, filling bag, inflatable (exhaust), date printing, full packaging process and automatic counting.
- Perfect automatic alarm protection function, minimize loss, help timely troubleshooting.
- Packaging design diversified, back closure, Angle, bag, punching, etc.

(三) 适用范围

- 该设备能完成计量、充填等工作,适用于计量那些易流动或流动性差的粉粒状物料;如奶粉、蛋白粉、面粉、固体饮料、可可粉、鸡粉、白砂糖、食品添加剂、香精香料等。

Applications

- The D set packing machine is suitable to packaging powder, such as milk powder, coffee powder, tea powder, protein powder, spices, sweet flour, flour etc.

(四) 技术规格 Specifications

机 型 (Type)	参数 (Specification)
计量范围 (Measuring range)	10-5000g
计量速度 (Metering speed)	10-50bags/min
计量精度 (Metering accuracy)	±2%
机器质量 (Metering weight)	80kg
电源规格 (Total power)	220V,50/60Hz,2KW
外形尺寸 (Machine dimension)	300X890X1640mm
制袋长度 (Bag length)	80-300mm
制袋宽度 (Bag width)	60-200mm
卷膜直径 (Film roll diameter)	Max.320mm
包装速度 (Packing speed)	5-60bags/min

封口形式 Type of bag

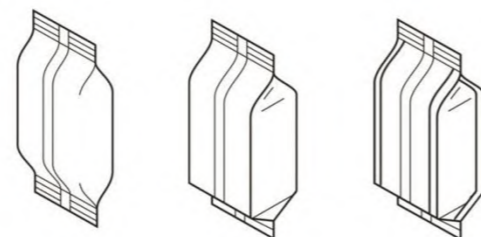

注:速度与产品特性和质量有关(Note: Speed is related to product characteristics and quality)



(五) 部件组成 Parts



螺杆计量机	
ZV-15L	0.5-220g
ZV-30L	10-500g
ZV-50L	50-5000g
ZV-100L	5kg-25kg

Auger metering machine	
ZV-15L	0.5-220g
ZV-30L	10-500g
ZV-50L	50-5000g
ZV-100L	5kg-25kg

型号	管径	流量	容量
ZV-YL60	Φ89	1m³/h	60L
ZV-YL120	Φ102	2m³/h	120L
ZV-YL180	Φ114	3m³/h	280L
ZV-FL400	Φ141	5m³/h	400L
ZV-FL700	Φ159	7m³/h	700L

Type	Pipe	Flow	Capacity
ZV-YL60	Φ89	1m³/h	60L
ZV-YL120	Φ102	2m³/h	120L
ZV-YL180	Φ114	3m³/h	280L
ZV-FL400	Φ141	5m³/h	400L
ZV-FL700	Φ159	7m³/h	700L

Three-phase 380V, 50/60Hz, 4KW (standard)
Single-phase 220V, 50/60Hz, 4KW

螺杆计量机
Auger metering machine

螺杆提升机
Screw auger conveyor

LD 系列链斗式半自动配套体系

Semi-automatic packaging machine combined with chain buckets

LD-420C/520C/720C

封口形式
Type of bag

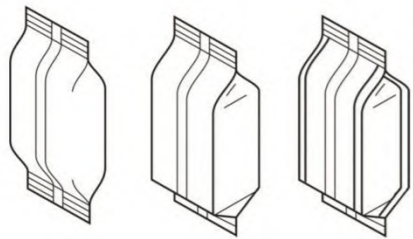

(一) 机械组成

- 1.LD系列主机
- 2.成品输送机
- 3.人工投料输送机

(二) 主要性能和结构特点

- 人工计量投料。
- 链斗式输送方便投奖票、奖品、或多种物料包装。
- 整套配置经济实惠。

(三) 适用范围

- 易碎物料：薯片、虾片、薯条。
- 不易自动计量的散状物料：糖果、果冻、豆芽、茶叶、水饺。
- 小袋入大袋：若干小包药品、食品、日用品等入一大包。

Option

- 1.LD series main frame
- 2.Manual feeding conveyor
- 3.Product conveyor

Feature

- Material measuring by manual.
- It's convenient to input, and uneasy measuring,material or multi-type packaging products.
- A complete set of machines are economical and practical.

Applications

- Fragile material: Chips, shrimp slices, crispy rice.
- Uneasy measuring material: candy jelly, bean sprouts, tea leaves, dumpling.
- The pouch bag into big bag of drugs, commodity, daily use. Food, small hardware etc.

LD 系列液体计量包装系统

Automatic liquid packaging machine

LD-420L/520L/620L/720L



封口形式
Type of bag

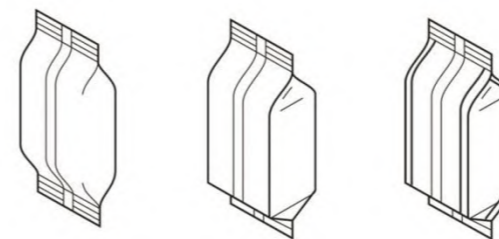

(一) 机械组成

- 1、LD基础主机
- 2、小型液体泵 (50-500ml)
- 3、中型液体泵 (100-1000ml)
- 4、大型液体泵 (500-5000ml)
- 5、液体泵计量机

(二) 主要性能和结构特点

- 包装机同液体或者膏体泵配套可实现不同粘度的液体或膏体的全自动包装。
- 整套设备联动控制，自动控制供料，无料不包装，不浪费。
- 液体泵与物料接触部分为316不锈钢，不易生锈。

(三) 适用范围

- 适用于普通形态、粘稠形态、高粘度液态物料的全自动化包装，如花生酱、番茄酱、洗发水、沐浴露、面霜、调味料、果酱、调味酱、牛奶、果汁、蛋黄酱等。

(四) 技术规格 Specifications

机 型 (Type)	LD-420	LD-520	LD-620	LD-720
薄膜宽度 (Film width)	Max.420mm	Max.520mm	150-Max.620mm	150-Max.720mm
制袋长度 (Bag length)	80-300mm	60-400mm	60-450mm	60-500mm
制袋宽度 (Bag width)	60-200mm	100-250mm	65-300mm	65-350mm
卷膜直径 (Film roll diameter)	Max.600mm	Max.600mm	Max.600mm	Max.600mm
包装速度 (Packing speed)	5-60bag/min	5-40bag/min	5-35bag/min	5-30bag/min
制袋体积 (Making-bag volume)	1000ml	2000ml	3000ml	5000ml
薄膜厚度 (Film thickness)	0.04-0.12mm	0.04-0.12mm	0.04-0.12mm	0.04-0.12mm
电源规格 (Power Supply)	220V,50/60Hz,3KW	220V,50/60Hz,3KW	220V,50/60Hz,3.2KW	220V,50/60Hz,3.5KW
机器尺寸 (Machine size)	(L)1217X(W)1015X(H)1343mm	(L)1488X(W)1080X(H)1490mm	(L)1488X(W)1180X(H)1550mm	(L)1780X(W)1350X(H)2050mm

Option

- 1 . LD basic machine
- 2 . Small type filling pump(50-500ml)
- 3 . Middle type filling pump(100-1000ml)
- 4.Large type filling pump(500-5000ml)
- 5 . Liquid measuring pump

Feature

- The packaging machine matched with liquid pump or paste pump,can pack different liquid or cream automatically.
- The whole system is linkage control, automatic feeding,stop working without materials.
- The contact parts with food is made of 316# high quality stainless steel, it will never get rust.

Applications

- Suitable for normal type, haft ropy type, high ropy type liquid items, such ketchup, peanut butter, shampoo, scream, edible oil, jam, milk,juice, etc .

LD 系列倾斜式包装机 Inclined Vertical Packaging Machine

(一) 机械组成

- | | |
|-----------|------------|
| 1、Z型物料提升机 | 6、易撕口装置 |
| 2、成品输送机 | 7、灌水装置 |
| 3、热转印打码机 | 8、充氧气/氮气装置 |
| 4、插角装置 | 9、除静电装置等 |
| 5、打孔装置 | |

Option

- | | |
|-----------------------------|--|
| 1、Z type bucket elevator | 6、Tear device; Easy tearing mouth device |
| 2、finished product conveyor | 7、Water filling device; |
| 3、Thermal transfer printer | 8、Oxygen/nitrogen filling device |
| 4、Angle fold device | 9、Static elimination device, etc |
| 5、Hole-punching device | |

(二) 可配套定量系统

- | | |
|---------|------|
| 1、电脑组合秤 | 3、量杯 |
| 2、线性秤 | |

Measurement Options

- | | |
|----------------------------|-------------------|
| 1、Combination weigher | 3、Volumetric cups |
| 2、Linear electronic scale; | |

(三) 主要性能和结构特点

- 制袋器35度倾斜式设计，减小下料冲击力，同时降低投料高度，方便人工操作；
- 配置电子显示触摸屏，人机界面，操作性强；
- 气动投料装置&高强度感应探头；
- 圆筒式接料斗&气动物料挡块，保证了包装的有序化和准确性；
- 下料挡块，最大程度保持物料原状；
- 可配置灌水装置，增加鲜存活率；
- 可配置充氧气/氮气装置，保鲜效果更佳；

Feature

- The 35 degree inclined design of the bag former reduces the force when material falling. And also reducing the feeding height for easier manual operation;
- Equipped with electronic touch screen, man-machine interface, strong operability ;
- Pneumatic feeding device & high-intensity sensor probe ;
- Cylindrical hopper & pneumatic feeding block ensure the orderly and accuracy of packaging;
- Filling block: maintaining the original state of the material better
- Water filling device is optional to increase the survival rate of fresh food
- Oxygen/nitrogen filling device is optional for better freshness-preservation ability

(四) 适用范围

- 适用于打包各种生鲜食品，如活鱼、海鲜、蔬菜瓜果等；
- 适用于打包各种易碎产品，如薯片、饼干、甜点、烘焙产品等；

Applications

- Suitable for packaging various fresh foods, such as live fish, seafood, vegetables, fruits, etc.
- Suitable for packaging various fragile products, such as potato chips, biscuits, desserts, bakery products, etc.



(五) 技术规格 Specifications

机 型 (Type)	LD-520Q
薄膜宽度 (Film Width)	Max.520mm
制袋长度 (Bag Length)	60-400mm
制袋宽度 (Bag Width)	100-250mm
卷膜直径 (Film roll diameter)	Max.320mm
包装速度 (Packing Speed)	5-60 bags / minute
计量范围 (Measuring Range)	200-2000ML
薄膜厚度 (Film Thickness)	0.04-0.12mm
电源规格 (Power Supply)	220V,50/60HZ,3KW
机器尺寸 (Machine Size)	1815mm*1175mm*1350mm

封口形式 Type of bag

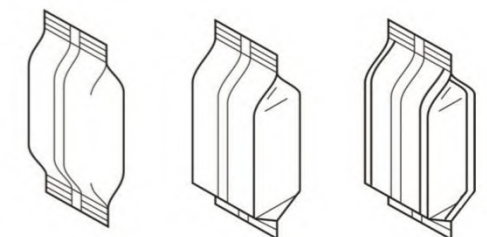

LD 系列充满式包装机

Automatic liquid packaging machine

(一) 机械组成

- 1、转子泵
- 2、输送管道
- 3、液体包装机
- 4、成品输送机

Option

- 1、Rotor pump
- 2、Feeding pipe
- 3、Vertical liquid packaging machine
- 4、Vertical liquid packaging machine

(二) 主要性能和结构特点

- 可以自动定量，自动输送物料入袋并封口；
- 具有袋成形、计量、重量调节、装袋、封口、切断、包装等功能；
- 配置电子显示触摸屏，人机界面，操作性强；
- 采用双滚筒排气装置，可把袋内的空气排干净，实现无空气包装；
- 采用松下PLC全电脑编程控制，定位精确，性能稳定可靠；
- 配合不同的物料输送泵。能够实现物体在高温状态下的自动定量充填包装，能有效的提高生产效率，避免因细菌入侵而造成的二次污染；
- 整机基本由不锈钢材质制造，符合食品卫生标准；
- 能有效的提高生产效率，减少人工成本；
- 包装成品比人手包装更美观，更牢固

Feature

- Quantitating automatically & feeding automatically ;
- Combining measuring, weight adjusting, bagging, sealing, cutting, packaging together ;
- Equipped with electronic touch screen, man-machine interface, strong operability ;
- Using double drum exhaust device to achieve airless packaging;
- Using Panasonic PLC to make positioning more accurate and performance more stable ;
- Equipped with different material delivery pumps to make the liquid can be automatically filled and packaged even in high temperature state, which improves production efficiency and avoids secondary pollution;
- The whole machine is made of SS304 which meets food hygiene standards ;
- Improving the production efficiency and reduce Labor cost.
- The packaging is more beautiful and firmer

(三) 适用范围

- 适用于各种流体、半流体的液体、膏体产品；
- 食品类：黄油、豆浆、酱油、饮料、果酱、馅料等；
- 非食品类：糨糊、洗涤剂、润滑油、机油等。

Applications

- Suitable for all kinds of fluid, semi-fluid liquid and paste products;
- Food categories: soy milk, soy sauce, beverages, peanut butter, jam, fillings, etc.;
- Non-food categories: paste, detergent, lubricating oil, engine oil, etc.

(四) 技术规格 Specifications

机 型 (Type)	LDQM520
薄膜宽度 (Film Width)	220-520mm
制袋长度 (Bag Length)	200-500mm
制袋宽度 (Bag Width)	100-250mm
卷膜直径 (Film roll diameter)	Max.320mm
包装速度 (Packing Speed)	5-4bags / minute
包装重量 (Packing Weight)	≤5KG
薄膜厚度 (Film Thickness)	0.060.12mm
电源规格 (Power Supply)	220V,50/60HZ,2.5KW
机器重量 (Machine Weight)	400KG

封口形式 Type of bag

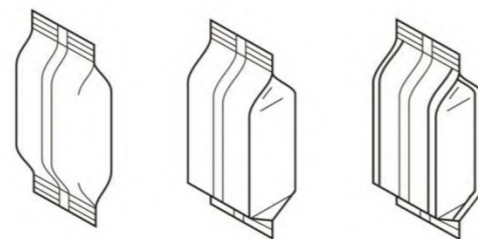

LD 系列四边封立式包装机

Series four side sealed vertical packaging machine

LD-420



(二) 主要性能和结构特点

- 采用伺服驱动系统，具有精度高、性能稳定等优点。
- 配备安全防护，符合企业安全管理要求。
- 采用智能温控，温度控制准确，保证封口美观平整。
- 超大显示触摸屏构成驱动控制核心，最大限度提高了整机的控制精度、可靠性和智能化程度。
- 本机与计量配置可自动完成计量、送料、充填制袋、充气(排气)、日期打印的全部包装过程，并自动完成计数。
- 完善的自动报警器保护功能，将损耗降到最低，帮助及时排除故障。

(三) 适用范围

- 该设备能完成计量、充填等工作，适用于计量那些易流动或流动性差的粉粒状物料；如奶粉、蛋白粉、面粉、固体饮料、可可粉、鸡粉、白砂糖、食品添加剂、香精香料等。

(四) 技术规格 Specifications

机 型 (Type)	参数 (Specification)
计量范围 (Measuring range)	10-5000g
计量速度 (Metering speed)	10-50bags/min
计量精度 (Metering accuracy)	±2%
机器质量 (Metering weight)	80kg
电源规格 (Total power)	220V,50/60Hz,2KW
外形尺寸 (Machine dimension)	(L)1640mmX(W)300X(H)890mm
制袋长度 (Bag length)	80-300mm
制袋宽度 (Bag width)	60-200mm
卷膜直径 (Film roll diameter)	Max.320mm
包装速度 (Packing speed)	5-60bags/min

Feature

- The servo drive system, has the advantages of high precision, stable performance.
- Equipped with safety protection so as to meet the requirements of enterprise safety management.
- Intelligent temperature control, accurate temperature control, ensure nice flat seal.
- Constitute a large display touch screen drive control core, maximum limit to improve the control precision, reliability and the intellectualized degree of the machine.
- The machine and measuring configuration can be done automatically measuring, feeding, filling bag, inflatable (exhaust), date printing, full packaging process and automatic counting.
- Perfect automatic alarm protection function, minimize loss, help timely troubleshooting.

Applications

- The D set packing machine is suitable to packaging powder, such as milk powder, coffee powder, tea powder, protein powder, spices, sweet flour, flour etc.

LD 系列异型袋包装机

Series special-shaped bag packaging machine

LD-320YX



(二) 主要性能和结构特点

- 可在包装过程中自动完成充填、计量、制袋、封口、切断、计数、热压批号等全部工作，光电跟踪定位无需调整；
- 智能控制系统、中英文LCD显示屏。只需设定参数即可精确控制系统运作；
- 热封器对袋边均匀加热控制，上下两侧可单独调温；
- 更换刀具可实现各类不同形状的袋子，持有回收废料装置，可常时间清理一次废料，节约时间，结合双轮拉袋轮拉袋，使拉袋更平稳，袋子更美观，切袋平稳可靠不卡袋，操作简单，可配置色带打码机，进行排打批号、保质期等；

(三) 适用范围

- 本机适用于医药、日化、食品、农药行业的液体、膏体、酱体物料。如洗发水、沐浴露、面霜、果汁、果酱、调味酱等。

(四) 技术规格 Specifications

机 型 (Type)	LD-320YX
计量范围 (Measuring range)	球阀泵/Ball valve pump
封装形式 (Package form)	异形袋/Shaped bag
剂量范围 (Dosage range)	1-50ml(可根据客户要求订制更大重量/Can be customized according to customer requirements)
制袋长度 (Bag length)	40-160mm
制袋宽度 (Bag width)	20-110mm
包装速度 (Packing speed)	30-60bag/min(以实际物料而定/According to the actual material)
控制系统 (Control system)	PLC控制系统/PLC control system
控制功率 (Control power)	220V,50Hz,2KW
机器重量 (Machine quantity)	300KG
机器尺寸 (Machine size)	(L)780X(W)750X(H)1800mm

Feature

- It can automatically complete the filling, measuring, bag-making, sealing, cutting off, counting, hot pressing batch number and other work in the process of packaging, and there is no need to adjust the photoelectric tracking and positioning;
- Intelligent control system, LCD display screen in Chinese and English. The operation of the system can be precisely controlled by only setting the parameters;
- The heat sealer uniformly heats the edges of the bag, and the upper and lower sides can be individually adjusted for temperature;
- Changing the cutter can realize all kinds of bags of different shapes. With a waste recycling device, you can clean up the waste at a regular time, saving time. Combined with the double-wheeled bag-drawing wheel to pull the bag, the bag is more stable, the bag is more beautiful, and the bag cutting is stable and reliable. and the bag is not jammed. Easy to operate, can be equipped with ribbon coding machine, for batch number, expiration date, etc;

Applications

- Suitable for packaging medicine, daily chemicals, food, liquid, paste and paste materials in pharmaceutical, Such as shampoo, shower gel, cream, juice, jam, sauce and so on.

LD 系列立式自动包装机

Vertical automatic packaging machine

LD-320/380



LD-320B/LD-380B
链斗式自动包装机
Semi-automatic packaging machine with measuring cups equipment

LD-320AB/LD-380C
容积+链斗式自动包装机
Fully automatic packaging machine with volumetric cups and chain-type volumetric batchers

LD-320D/LD-380D
粉剂自动包装机
Powder automatic measure packaging machine

LD-320A/LD-380A
容积式自动包装机
Full automatic packaging machine with measuring cups equipment

LD-320AS/LD-380AS
线性秤自动包装机
Linear Electronic Scale packaging machine

LD-320S/LD-380S
三角包自动包装机
Triangle seal's horizontal seal

LD-320L/LD-380L
液体自动包装机
Liquid automatic packaging machine

计量范围 (Metering volume) : 100-300ml
计量速度 (Metering speed) : 10
计量精度 (Metering accuracy) : ±3%

(一) 封口样式 Seal style

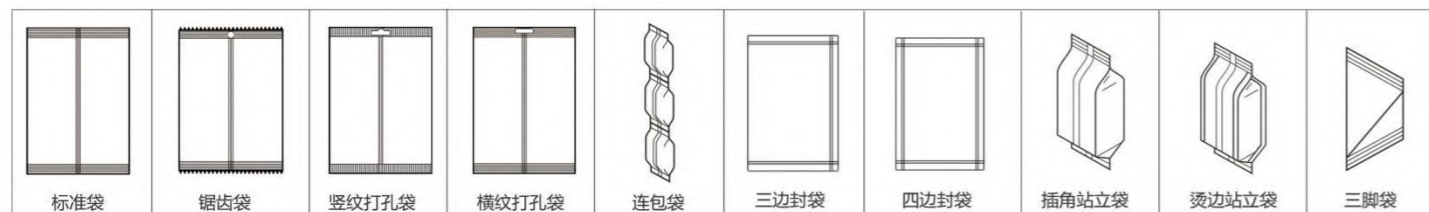

立式自动包装机参数

Vertical auto packaging machines

(二) 机械组成

1. 色带式打印装置
2. 定包切断装置
3. 真空自动上料装置
4. 在线称重自动调整重量装置

Option

1. Hot stamp ribbon coder
2. Batch cutter
3. Vacuum loader
4. On-line check weighing with auto feedback weight

(三) 技术规格 Specifications

机 型 (Type)	LD-320	LD-380	LD-320S
薄膜宽度 (Film width)	120-320mm	180-380mm	80-220mm
制袋长度 (Bag length)	50-200mm	60-280mm	50-200mm
制袋宽度 (Bag width)	20-150 mm	20-180mm	20-150mm
卷膜直径 (Film roll diameter)	Max.300mm	Max.320mm	320mm
包装速度 (Packaging rate)	5-50bag/min	5-50bag/min	5-50bag/min
计量范围 (Measuring range)	5-200ml	5-250ml	5-200ml
薄膜厚度 (Film width)	0.04-0.07mm		
电源规格 (Power Supply)	220V 50/60Hz 2.2KW	220V 50/60Hz 2.5KW	220V 50Hz 2.0KW
机器尺寸 (Machine size)	(L) 970x (W) 680x (H) 1950mm	(L) 1100x (W) 800x (H) 2150mm	(L)970x (W) 825x (H) 2020mm
机器质量 (Machine quality)	about 300kg	about 450kg	about 300kg

(四) 主要性能和结构特点

- 高精度构造，操作维修简易。
- PLC、触摸屏、步进电机控制，袋长设定方便、准确。
- 变频调速，简单、快捷、省时省膜。
- 从充填、制袋、打印日期、充气（排气）一次性完成。
- 选配装置：连包控制装置。

Feature

- High precision structure for simple and easy operation and repair.
- PLC touch screen, step motor control, easy and accurate to set the bag length.
- It's owns simple circuitry and outstanding function.
- The machine completes the whole procedure of filling, bagging, date printing,charging (exhausting) automatically.
- Select device: Linked bags device.

(五) 适用范围

- 适用各类膨化食品、虾条、糖果、花生、爆米花、大米等颗粒状、条状、片状固体物料的包装。

Applications

- Suitable for packaging of various kinds of puffed food, shrimp bars candies, peanuts, popcorns, rice and such materials in grain or piece.



多头电脑组合称量称

Combination balance with multi computer computer



十头电脑组合秤
(10 heads weigher)

十四头电脑组合秤
(14 heads weigher)

二十四头电脑组合秤
(24 heads weigher)

(一) 主要性能和结构特点

- 全新设计, 亮丽外观, 结构更合理, 技术更先进。
- 高精度高速度的完美结合通过电脑计算从丰富的重量组合中瞬间选出最佳组合, 高精度数字式传感器使准确计量瞬间得以实现中 / 英文液晶显示屏操作系统。
- 防水防尘式设计, 所有部件采用不锈钢, 干净卫生。全密封设计防止了物料的堆积且清扫方便。
- 能根据被计量物的特性, 细微调整料斗门的开闭速度, 防止破碎及卡料。
- 自我诊断功能。兼容性强, 直接安装在包装机上方。结构更为紧凑。
- 为您节省大量原材料与劳动力成本, 投资回报快。

(二) 适用范围

- 糖果、瓜子、薯片、开心果、花生、果仁、果脯、果冻、冷冻汤圆、饼干、蜜饯、樟脑丸、葡萄干、杏仁、巧克力、榛子、谷物、宠物食品、膨化食品、五金件、塑料件等各种颗粒状、片状、条状、不规则形状物料的定量称重。

(三) 技术规格 Specifications

机 型 (Type)	LD-8	LD-10	LD-12	LD-14	LD-16
计量头数 (Measuring head)	8	10	12	14	16
单次称量 (Single weighing range)	10-600g	10-1000g	10-1000g	10-2000g	10-1000g
称量精度 (Accuracy)	±0.3-1.5g				
称量速度 (Weighing speed)	60bag/min	70bag/min	100bag/min	120bag/min	180bag/min
料斗容量 (Hopper volume)	1300ml		1700ml	1300ml	1300ml
料斗形式 (Bucket type)	双排无记忆斗 (double row unrecorded bucket)		单排斗 (single row bucket)	双排无记忆斗 (double row unrecorded bucket)	
产品预设模式 (Product preset mode)	99种				
控制元件 (Control element)	荧光显示管 (256X64点5.7寸) Fluorescent light display tube(256*64pixel)			10.4寸液晶触摸屏 10.4LCD display tube	

Feature

- Combining the hi-precision and hi-rate can vote in the best compounding from the abundant weight compounding by computerizing. Hi-rate digital sensor can give in a short time.
- Operation system of LCD with Chinese-English .
- All the parts adopt the stainless with clean and sanitation by the design of waterproof and dustproof. Design of complete airproof can prevent the material stacking and ease to clean.
- To adjust slightly the rate of the hopper door to avoid crashing and blocking the material.
- Self-diagnosis function.
- To fix directly above the packing machine and the structure is more close with better compatibility.
- To save a lot of raw material and the cost of labour force and get the return quickly.

Applications

- All kinds of grain material, sheet material, strip material and abnormality material which such as candy, melon seeds, chips, peanut, nutlet, preserved fruit, jelly, biscuit, confection, camphorball, currant, almond, chocolate, filbert, cornpet foodstuff, dilatant foodstuff, hardware and plastic can be weighed by the ration.

输送机系统

Conveyor series



Z型物料输送机 Z-Type Bucket Elevator

主要性能和结构特点

- 适合于输送易碎物料
- 采用国家级食品塑料, 保障食品安全
- 规格可按客户要求定做
- 性能稳定, 噪音小
- 安装拆卸简单, 方便清洗
- 结构简单, 价格便宜

适用范围

- 通过链条的传动, 带动料斗提升, 适用于粮食, 食品, 饲料和化工等部门的片状, 块状的升运。

Technical advantages

- Suitable to transport the materials which is easy crash.
- Adopt the food safety class plastic, to ensure the food safety.
- Easy to washing.
- work stable low noise.

Application

Suitable to deliver sheet, massive material etc, Such as food, feed and chemical industry. Conveyor to work through the chain of transmission with large lifting quantity and high lifting height.



斜坡输送机 Slope Elevator

主要性能和结构特点

- 高度, 皮带宽度和长度, 输送速度可完全根据客户需求定做
- 结构简单, 安装维护方便
- 应用范围广

适用范围

- 主要应用于块状, 颗粒类食品以及包装成品的输送。

Technical advantages

- The height, belt width & length and speed of convey or can be customize.
- Simple structure, easy to install.
- Economical, wide range of applications.

Application

- This conveyor is mainly used in bulk, grain food and the finished product.



成品输送机&成品转盘
Finished Product Conveyor Turn Table

主要性能和结构特点

- 有不锈钢和喷漆两种材质可供选择
- 有皮带和链板材质可供客户选择
- 可调节高度, 0.55-0.8M (根据型号而定)
- 成品转盘采用304#不锈钢, 具备360度旋转功能

适用范围

- 适用于包装好的成品袋输送至包装后检测设备或打包台。

Technical advantages

- There are stainless steel frame and painted frame for choose.
- Belt and chain plate for customer to choose.
- The height of the finished product conveyor can be adjusted, the range is 0.55-0.8 (depend on different model).
- Turn table made with 304 stainless steel, 360° turn.

Application

- Transport the finished products to the inspection equipments or the package platform.



真空上料机 Vacuum Conveyor

主要性能和结构特点

- 上料速度快
- 连续工作长时间
- 无泄漏现象, 清洁、卫生, 适合于洁净厂房
- 操作简单, 拆装和清洗方便, 符合卫生要求

Technical advantages

- Feeding speed is fast.
- No leakage, clean hygiene.
- Simple structure, easy to install.
- Easy operation.



成品输送机 Finished product conveyor

主要性能和结构特点

- 线速度: 18米/分钟
- 机架材质: 机架采用304不锈钢, 传动部分采用钢件表面处理浸镍或者发黑及铝型材, 与食品接触部分采用食品级304不锈钢材质。

Technical advantages

- Line speed: 18 m/min
- Finished product conveyor frame material: it is made of 304 stainless steel, and the transmission part is made of steel surface treated with nickel or black and aluminum profiles, the contact food part is made of food grade 304 stainless steel.

食品包装专用迷你制氮机

Mini nitrogen generator for food packaging

空气净化部分组件:

1. 一级粗过滤器
2. 二级精过滤器
3. 冷冻式干燥机
4. 三级超精过滤器
5. 空气缓冲罐
6. 除油器

Air purification part

1. First-class filters
2. Second-class filters
3. Frozen dehydrator
4. Third-class filters
5. Air storage tank
6. Effective degreaser

氮气制取部分组件:

1. 氧氮分离组件
2. 氮气缓冲罐
3. 系统控制器
4. 氮气出口过滤器

Nitrogen separation part

1. O₂/N₂ separator
2. Nitrogen buffer tank
3. PLC controller
4. Outlet filters

空气源

空压机



Air source

空压机



(二) 迷你制氮机选型表 Selection table of mini nitrogen for food packaging

型号规格 (Types and Specifications)	产氮量 Nitrogen-making Capacity Nm ³ /h	功率 Power/W	纯度 Purity%	气源压力 Air input pressure	产氮压力 Nitrogen-making pressure Mpa	外形尺寸 Shape Dimension mm
(TY-3) 普通型 (Common type)	3	500	≥99.5	0.8-1.0	0.1-0.65	570*570*950
(TY-3) 豪华型 (Luxury)	3	500	≥99.5	0.8-1.0	0.1-0.65	600*580*1200

注: 可供一台枕式包装机充气, 配套空压机的排气量: ≥0.4 m³/min, ≤含油量: 3ppm Note: for two inflatable pillow packing machine supporting the displacement of air compressor: ≥0.4 m³/min, ≤oil content: 3ppm.

(TY-3) 普通型 (Common type)	5	500	≥99.5	0.8-1.0	0.1-0.65	570*570*1200
(TY-3) 豪华型 (Luxury)	5	500	≥99.5	0.8-1.0	0.1-0.65	600*580*1500

注: 可供二台枕式包装机或二台立式包装机充气, 配套空压机的排气量: ≥0.6 m³/min, 含油量: 3ppm Note: for two inflatable pillow packing machine supporting the displacement of air compressor: ≥0.6 m³/min, ≤oil content: 3ppm.

(TY-3)	10	1000	≥99.5	0.8-1.0	0.1-0.65	1350*1200*1650
--------	----	------	-------	---------	----------	----------------

注: 可供四台枕式包装机或二台立式包装机充气, 配套空压机的排气量: ≥0.9 m³/min, 含油量: 3ppm Note: pillow packing machine for four fire two sets of vertical packaging machine inflatable and the supporting air compressor displacement: ≥0.9 m³/min, ≤oil content: 3ppm.

(TY-3)	10	1000	≥99.5	0.8-1.0	0.1-0.65	1400*1180*1670
--------	----	------	-------	---------	----------	----------------

注: 可供五台枕式包装机或三台立式包装机充气, 配套空压机的排气量: ≥1.25 m³/min, 含油量: 3ppm Note: pillow packing machine for four fire two sets of vertical packaging machine inflatable and the supporting air compressor displacement: ≥1.25 m³/min, ≤oil content: 3ppm.

选别秤 (重量检测机)

Weight detecting machine

(一) 主要性能和结构特点

- 采用世界先进的数字式称重单元, 实现高速、稳定计量。
- 专利的秤架结构, 确保精确、稳定。
- 液晶显示触摸屏操作系统、中英文操作界面, 方便易学。
- 强大的数据统计功能, 记录每班的检测数据。
- 采用拆卸式传送带, 方便维护。
- 自我诊断功能: 当Rom/Ram, A/D光电管通讯异常时会有出错显示。
- 标准重量五个分区, 可储存10组产品数据库。

(二) 适用范围

- 用于检测单个产品重量与设定目标值是否相符, 并由分选装蓝自动剔除不合格标准的产品。

Features

- Adopt digital weighting unit which is advanced in the world, to realize high speed and stable numeration.
- Patented balance frame structure to make sure accuracy and stability.
- The touch screen operating system is liquid crystal display with the English-Chinese operator interface, which is convenient and easy to learn.
- Powerful data statistics function to record every unit of test data.
- Adopt adjustable type conveyor belt so that it's convenient to maintain.
- Self failure diagnosis, it will display the error when Rom/Ram, A/D phototube communicate abnormally.
- The standard weight has five divisions, which can save ten groups.

Applications

- Suitable for test if per unit product weight match up with the value of goal set and substandard product will be rejected by sorting unit automatically.



(三) 技术规格 Specifications

机 型 (Type)	10-99g	100-200g	201-400g	401-999g	1000-10000g
速度 (rate)	65bag/min	60bag/min	50bag/min	45bag/min	40bag/min
精度 (precision)	±0.5g				
最小刻度 (Minimum scale)	0.1g				
产品预设模式 (Predesign pattern)	10种 (10kinds)				
尺寸 (Size)	(L)1050*(W)681*(H)1260				
电压 (voltage)	220V				
功率 (Power)	300W				

金属检测仪

Dczj metal detector

(一) 主要性能和结构特点

- 机体采用不锈钢结构, 外观既美观又防锈, 便于清洗。
- 全新模拟电路与数字电路结合, 大大提高了产品可靠性和智能化程度。
- 采用新型触摸屏输入及大规模集成电路组成, 由CPU完成模拟信号收集处理, 输出, 自动搜索所检测物金属含量的最佳点, 大大提高了检测的灵敏度和可靠性。
- 采用人性化界面设计。整个操作过程简洁直观, 人机界面一目了然, 所有功能在屏幕上直接操作就可以完成所执行的功能。
- 可动态直观显示Fe和SUS动态检测结果及灵敏度。

(二) 适用范围

- 用于检测漏落于原料或产品中的各种金属杂质 (铁, 铜, 铅, 不锈钢等不合格标准的产品)

Features

- The body is made of stainless steel, which is beautiful in appearance, rust prevention and easy to clean.
- Analog design is combined with digital design, greatly improving reliability and intelligence.
- Adopt new touch screen input and large scale integrated circuit CPU collects analog signal.
- Adopt the set of user-friendly interface, ensuring that the entire operation is simple, human seen at a glance and all commands can be done by operating the interface.
- Dynamically and visually display the dynamic test results of Fe and SUS, the sensitivity of current automatically.

Applications

- Apply to detect metal leakage (such as iron, copper, lead, stainless steel, etc) fallen in material and goods, and automatically.

(三) 技术规格 Specifications

机 型 (Type)	LD-100	LD-150	LD-200	LD-250	LD-300
检测窗口高度 (Detecting window height (mm))	100	150	200	250	300
有效检测宽度 (Effectivedetecting width (MAX) (mm))	400	400	440	440	440
Fe (mm)- 铁球- 钢球 iron ball- steel ball (mm)	0.8-1.0	1.0-1.2	1.2-1.5	1.5-2.0	2.0-2.5
304Sus (mm) 304-306 (mm)	1.5-2.0	2.0-2.3	2.3-2.5	2.5-3.0	3.0-3.5
机架材质 (Frame material)	不锈钢 (Stainless steel)	不锈钢 (Stainless steel)	不锈钢 (Stainless steel)	不锈钢 (Stainless steel)	不锈钢 (Stainless steel)



四斗称

Balance with four hopper

(一) 主要性能和结构特点

- 数字式传感器使精确计量瞬间得以实现。
- 微电脑控制系统, 采用双振动给料, 进口仪表, 技术先进, 操作简便。
- 全不锈钢密封机体, 具防腐防尘之功效。
- 计量斗能快速拆卸, 便于清洗维修。
- 可应用户要求, 进行不同分装形式组合, 扩大秤量范围。
- 兼容性强, 易与其他包装设备配合使用。

(二) 适用范围

- 白糖、盐、种子、大米、味精、饲料、奶粉、咖啡、黄豆、芝麻等日用调味品等小颗粒状、粉状物料的定量称重。

Features

- Adopt digital sensor to realize the accuracy measure in a moment.
- Microcomputer control system adopts double vibration infeeding, importing instrumentation technology and easy operation.
- Due to the sealed balance body with full stainless steel, it has dustproof and anticorrosive function.
- The measure hopper can be disassembled quickly, cleaned and repaired conveniently.
- Combine with all kinds of repacking form follow requirements of clients, to expand the scope of weighing.
- High compatibility, it is easy to combine with other packaging machine.

Applications

- Suitable for packaging granulated and powder material such as white sugar, salt, seed, rice, monosodium glutamate, fodder, milk powder, coffee powder, soybean, sesame, daily appliance and so on.

(三) 技术规格 Specifications

机 型 (Type)	LD-AX4-1	LD-AX4-2	LD-AX4-3
称重范围 (Weighing cap. (g))	5-300g	50-2000g	50-3000g
称量精度范围 (Accuracy)	0.5-1g	1-2g	1-3g
最大称量速度 (Max.Speed)	70wpm	50wpm	30wpm
料斗容量 (Hopper Volume)	500ml	3000ml	4500ml
参数预设数 (Control panel)	20		
最多可称量物料 (Max Mixing products)	4		
功率 (Power)	1200w		
电 源 (Power)	220v/50/60Hz/6A		
包装尺寸 (Packing dimension)	(L)1028X(W)1078X(H)825mm		(L)1215X(W)1156X(H)1025mm

