

**LANDPACK**

**佛山市揽德包装机械有限公司**

FOSHAN LAND PACKAGING MACHINERY CO.,LTD



**佛山市揽德包装机械有限公司**

FOSHAN LAND PACKAGING MACHINERY CO.,LTD

地址：佛山市南海区罗村新光源产业基地C7栋  
Add : Building C7 of New Lighting Source Industrial Base.  
Luocun, Nanhai District, Foshan City, GD, China

Tel : 0757-81807872 Fax : 0757-81807758

E-mail : yang@landpacking.com

Web : www.landpack.cn / www.landpack.com

专业提供8工位给袋机、水平给袋机、单工位给袋机  
颗粒、粉末、液体包装解决方案





# 公司简介 Company profile

揽德包装机械有限公司坐落于广东省佛山市，以其优越的地理位置和良好的市场口碑，赢得广大客户的支持。公司销售网络辐射全国各地，远销全球30多个国家和地区。

本公司是研发、制造和销售各种给袋机，包括但不限于单工位给袋机、水平给袋机、8工位给袋机及与之配套的其他相关设备；并提供全自动包装整体方案；

公司通过ISO9001质量管理体系认证，相关设备通过CE、SGS等认证。配备有丰富经验的研发、制造工程师队伍和专业的销售服务团队，确保您用合理的成本，获得性能稳定，外观卓越和人性化程度高的设备和优质满意的服务体验。

设备广泛适用于各种颗粒、液体、粉末；涉及行业包括：食品行业如干果、膨化食品如薯片；酱料行业如：番茄酱，辣椒酱、蓝莓酱；饮料，农产品原产材料等相关行业的生产中。

揽德包装机作为国内先进包装设备制造厂商，致力于为企业提供包装整体解决方案，令企业所需包装的过程得到质的提升，最大限度地解放了劳动力，避免了二次污染，以高效的方式提高企业的生产率。

LANDPACKAGING MACHINERY CO., LTD. IS LOCATED IN FOSHAN CITY, GUANGDONG PROVINCE. WITH ITS SUPERIOR GEOGRAPHICAL LOCATION AND GOOD MARKET REPUTATION, IT HAS WON THE SUPPORT OF CUSTOMERS. THE COMPANY'S SALES NETWORK RADIATES ALL OVER THE COUNTRY AND IS EXPORTED TO MORE THAN 30 COUNTRIES AND REGIONS AROUND THE WORLD.

THE COMPANY IS A MODERN PACKAGING EQUIPMENT ENTERPROSE WHICH DEVELOPS, MANUFACTURES AND SELLS ALL KINDS OF PREMADE BAG PACKING MACHINE, LIKE MINI DOYPACK PACKAGING MACHINE, HORIZONTAL PREMADE BAG PACKING MACHINE, ROTARTY TYPE PREMADE BAG PACKING MACHINE AND RELATED SUPPORTING EQUIPMENT TO PROVIDING FULL AUTOMATIC OVERALL PACKAGING SOLUTIONS.

THE COMPANY HAS PASSED ISO 9001 QUALITY MANAGEMENT SYSTEM CERTIFICATION, AND RELEVANT EQUIPMENT HAS PASSED CE AND SGS CERTIFICATION. EQUIPPED WITH A TEAM OF EXPERIENCED R & D AND MANUFACTURING ENGINEERS AND A PROFESSIONAL SALES AND SERVICE TEAM, YOU CAN GET STABLE PERFORMANCE, EXCELLENT APPEARANCE AND HIGH DEGREE OF HUMANIZATION EQUIPMENT AND HIGH QUALITY AND SATISFACTORY SERVICE EXPERIENCE AT REASONABLE COST.

THE EQUIPMENT IS WDELY USED IN ALL KINDS OF GRANULAR, LIQUID, POWDER MATERIAL, RELATED INDUSTRIES INCLUDE FOOD INDUSTRY SUCH AS DRIED FRUIT, PUFFED FOOD LIKE POTATO CHIPS, COOKIES, SAUCE INDUSTRY SUCH AS KETCHUP, CHILI SAUCE BLUEBERRY SAUCE; BEVERAGE INDUSTRY, AGRICULTURAL PRODUCTS RAW MATERIALS AND OTHER RELATED MATERIAL IN PRODUCTION.



CE 认证



ISO 认证



SGS 认证



TUV 认证



专利证书

# LD 系列旋转给袋包装机

## LD Series Rotary packaging machine

### LD-8200/8300

组合称量旋转给袋颗粒包装机  
Granule Rotary packing machine



### (一) 常规机械组成

- |            |          |
|------------|----------|
| 1. 打码机     | 6. 电磁阀   |
| 2. PLC控制系统 | 7. 温控仪   |
| 3. 开袋装置    | 8. 真空泵   |
| 4. 振动装置    | 9. 变频器   |
| 5. 气缸      | 10. 输出系统 |

### Mechanical components

- |                       |                           |
|-----------------------|---------------------------|
| 1. Code printer       | 6. electromagnetic valve  |
| 2. PLC control system | 7. Temperature controller |
| 3. bag opening device | 8. Vacuum pump            |
| 4. Vibration device   | 9. Inverter               |
| 5. Cylinder           | 10. Output system         |

### (二) 主要性能和结构特点

- 快速更换包装袋的规格，带宽大小一键自动调节。
- 单轴传动加内凸轮设计，包装速度快，运行更加稳定、维修更简单、减少次品率。
- 模块化加热、温控更精准、加热故障可报警提示。
- 先进的设计理念，降低了包材损耗，保证了设备运行的稳定性，延长了设备的运行寿命。
- 操作简单方便，采用先进的PLC+POD(触摸屏)电气控制系统，人机界面友好。
- 机器的包装范围广泛，可包装液体、酱体、颗粒、粉剂、固体各种可装袋物料，只需根据不同的计量装置即可。
- 本机适用预制好的包装袋，包装图案完美、封口品质好，从而提高了产品的品质与档次。

### Feature

- Rapid change of the specifications of the bag, bag width can be automatically adjusted by one button.
- Single shaft and the CAM design: packaging speed faster; more stable operation; maintenance easier and reduce defective rate.
- Modular heating, temperature control more accurate, heating fault have alarm prompt.
- Advanced design idea, reduce the material loss, ensure the stability of equipment operation, extend the operating life of the equipment.
- Simple and convenient operation, adopts the advanced PLC+POD (touch screen) electric control system and man-machine interface.
- Machine have wide packaging range, it can packaging: liquid, paste, granule, powder, solid various bagging materials only. According to the different material with different metering device.
- Machine use preformed bags & packaging design is perfect & good sealing quality to improve the quality and grade of the product.

### (三) 技术参数 Specification

机器型号 (Type)	组合称量旋转给袋颗粒包装机(Granule Rotary packing machine)	
	LD8200	LD8300
包装袋型 (Bag Type)	三边封, 四边封袋, 自立袋, 手提袋、壶口袋、拉链袋、复合袋等 3-side, 4 side sealing bag, stand-up bag, handbag, spout bags, zipper bag, compound bag, etc.	
包装尺寸 (Bag Size)	W: 70-200mm	W: 200-300mm
充填范围 (Filling Range)	10/1000g	10-2500g
包装速度 (Packing Speed)	40~60包/分钟 (其速度由产品自身充填量决定) 25~40包/分钟 (拉链袋) 40~60bag/min (speed is determined by the product filling quantity) 25~40 bags/min (for zipper pouch)	30~40包/分钟 (速度由产品灌装量决定) 25~35包/分钟 (拉链袋) 30~40 bags/min (speed is determined by the product filling quantity) 25~35 bags/min (for zipper pouch)
计量平均精度 (Average Precision)	<±1%	
总功率 (Total Power)	2.5KW	4KW
工作流程 (Work Flow)	1.上袋 2.打印生产日期 3.开拉链 4.充分张开袋子 5.填充, 振动 (可选) 6.填充后产品通过振动积集 7.排气 (选项), 关闭拉链, 热封 8.整形及输出产品 1.giving bag 2.coding date(option) 3.open zipper 4.open the top and bottom 5.filling,vibrate(option) 6.The filling product is integrated by vibration 7.exhaust(option),closing zipper,sealing 8.forming and output	
外形尺寸 (Dimensions)	1900mm X 1570mm X 1700mm (L*W*H)	2450mm X 1750mm X 1450mm (L*W*H)

### 工作流程 Work Process

- |                                       |   |
|---------------------------------------|---|
| 1 上袋 (Giving bag)                     | 5 填充, 振动 (可选)<br>filling,vibrate(option)                        |
| 2 打印生产日期 (Coding date)                | 6 填充后产品通过振动积集<br>The filling product is integrated by vibration |
| 3 开拉链 (opening zipper)                | 7 排气 (选项), 关闭拉链, 热封<br>exhaust(option),closing zipper,sealing   |
| 4 充分张开袋子<br>(Open the top and bottom) | 8 整形及输出产品<br>Forming and output                                 |

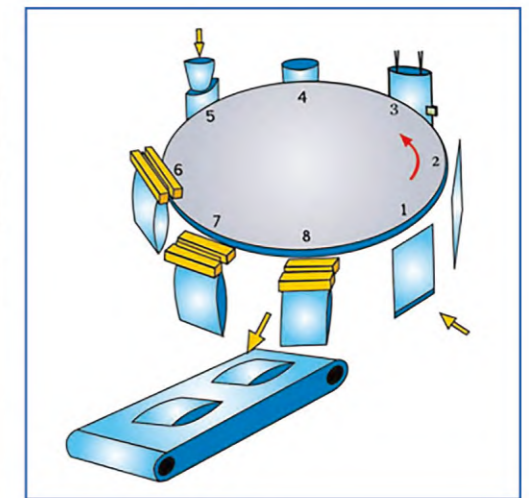
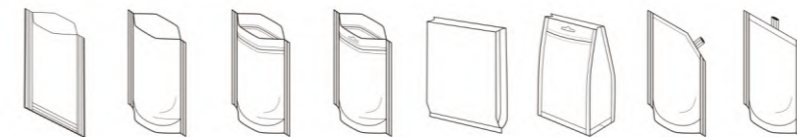

### (四) 适用范围

- 块料: 豆腐饼、鱼、蛋、糖果、红枣、谷物、巧克力、饼干、花生等
- 颗粒型: 结晶味精、颗粒状药物、胶囊、种子、化学品、糖、鸡精、瓜子、果仁、农药、化肥。

### Applications

- Block material: bean curd cake, fish, eggs, candy, red jujube, cereal, chocolate, biscuit, peanut, etc.
- Granular type: crystal monosodium glutamate, granular drug, capsule, seeds, chemicals, sugar, chicken essence, melon seeds, nut, pesticide, fertilizer.



# LD 系列旋转给袋包装机

## LD Series Rotary packaging machine

### LD-8200/8300

线性称量旋转给袋颗粒包装机  
Granule Rotary packing machine



### (一) 常规机械组成

- |            |          |
|------------|----------|
| 1. 打码机     | 6. 电磁阀   |
| 2. PLC控制系统 | 7. 温控仪   |
| 3. 开袋装置    | 8. 真空泵   |
| 4. 振动装置    | 9. 变频器   |
| 5. 气缸      | 10. 输出系统 |

### (二) 主要性能和结构特点

- 快速更换包装袋的规格, 带宽大小一键自动调节。
- 单轴传动加内凸轮设计, 包装速度快, 运行更加稳定、维修更简单、减少次品率。
- 模块化加热、温控更精准、加热故障可报警提示。
- 先进的设计理念, 降低了包材耗损, 保证了设备运行的稳定性, 延长了设备的运行寿命。
- 操作简单方便, 采用先进的PLC+POD(触摸屏) 电气控制系统, 人机界面友好。
- 机器的包装范围广泛, 可包装液体、酱体、颗粒、粉剂、固体各种可装袋物料, 只需根据不同的计量装置即可。
- 本机适用预制好的包装袋, 包装图案完美、封口品质好, 从而提高了产品的品质与档次。

### Mechanical components

- |                       |                           |
|-----------------------|---------------------------|
| 1. Code printer       | 6. electromagnetic valve  |
| 2. PLC control system | 7. Temperature controller |
| 3. bag opening device | 8. Vacuum pump            |
| 4. Vibration device   | 9. Inverter               |
| 5. Cylinder           | 10. Output system         |

### Feature

- Rapid change of the specifications of the bag, bag width can be automatically adjusted by one button.
- Single shaft and the CAM design: packaging speed faster; more stable operation; maintenance easier and reduce defective rate.
- Modular heating, temperature control more accurate, heating fault have alarm prompt.
- Advanced design idea, reduce the material loss, ensure the stability of equipment operation, extend the operating life of the equipment.
- Simple and convenient operation, adopts the advanced PLC+POD (touch screen) electric control system and man-machine interface.
- Machine have wide packaging range, it can packaging: liquid, paste, granule, powder, solid various bagging materials only. According to the different material with different metering device.
- Machine use preformed bags & packaging design is perfect & good sealing quality to improve the quality and grade of the product.

### (三) 技术参数 Specification

机器型号 (Type)	线性称量旋转给袋颗粒包装机(Granule Rotary packing machine)	
	LD8200	LD8300
包装袋型 (Bag Type)	三边封, 四边封袋, 自立袋, 手提袋、壶口袋、拉链袋、复合袋等 3-side, 4 side sealing bag, stand-up bag, handbag, spout bags, zipper bag, compound bag, etc.	
包装尺寸 (Bag Size)	W: 70-200mm	W: 200-300mm
充填范围 (Filling Range)	10/1000g	10-2500g
包装速度 (Packing Speed)	40~60包/分钟 (其速度由产品自身充填量决定) 25~40包/分钟 (拉链袋) 40~60bag/min (speed is determined by the product filling quantity) 25~40 bags/min (for zipper pouch)	30~40包/分钟 (速度由产品灌装量决定) 25~35包/分钟 (拉链袋) 30~40 bags/min (speed is determined by the product filling quantity) 25~35 bags/min (for zipper pouch)
计量平均精度 (Average Precision)	<±1%	
总功率 (Total Power)	2.5KW	4KW
工作流程 (Work Flow)	1.上袋 2.打印生产日期 3.开拉链 4.充分张开袋子 5.填充, 振动 (可选) 6.填充后产品通过振动积集 7.排气 (选项), 关闭拉链, 热封 8.整形及输出产品 1.giving bag 2.coding date(option) 3.open zipper 4.open the top and bottom 5.filling,vibrate(option) 6.The filling product is integrated by vibration 7.exhaust(option),closing zipper,sealing 8.forming and output	
外形尺寸 (Dimensions)	1900mm X 1570mm X 1700mm (L*W*H)	2450mm X 1750mm X 1450mm (L*W*H)

### 工作流程 Work Process

- |                                       |   |
|---------------------------------------|---|
| 1 上袋 (Giving bag)                     | 5 填充, 振动 (可选)<br>filling,vibrate(option)                        |
| 2 打印生产日期 (Coding date)                | 6 填充后产品通过振动积集<br>The filling product is integrated by vibration |
| 3 开拉链 (opening zipper)                | 7 排气 (选项), 关闭拉链, 热封<br>exhaust(option),closing zipper,sealing   |
| 4 充分张开袋子<br>(Open the top and bottom) | 8 整形及输出产品<br>Forming and output                                 |

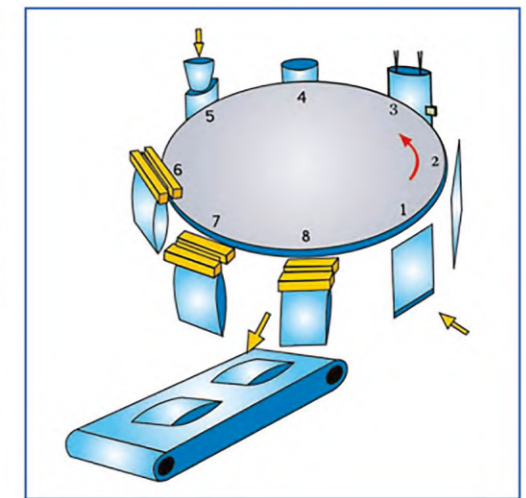
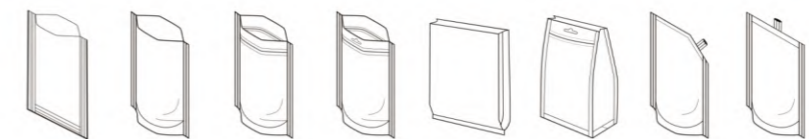

### (四) 适用范围

- 块料: 豆腐饼、鱼、蛋、糖果、红枣、谷物、巧克力、饼干、花生等
- 颗粒型: 结晶味精、颗粒状药物、胶囊、种子、化学品、糖、鸡精、瓜子、果仁、农药、化肥。

### Applications

- Block material: bean curd cake, fish, eggs, candy, red jujube, cereal, chocolate, biscuit, peanut, etc.
- Granular type: crystal monosodium glutamate, granular drug, capsule, seeds, chemicals, sugar, chicken essence, melon seeds, nut, pesticide, fertilizer.



# LD 系列旋转给袋包装机

## LD Series Rotary packaging machine

### LD-8200/8300

粉末计量旋转给袋包装机  
Powder Rotary packing machine

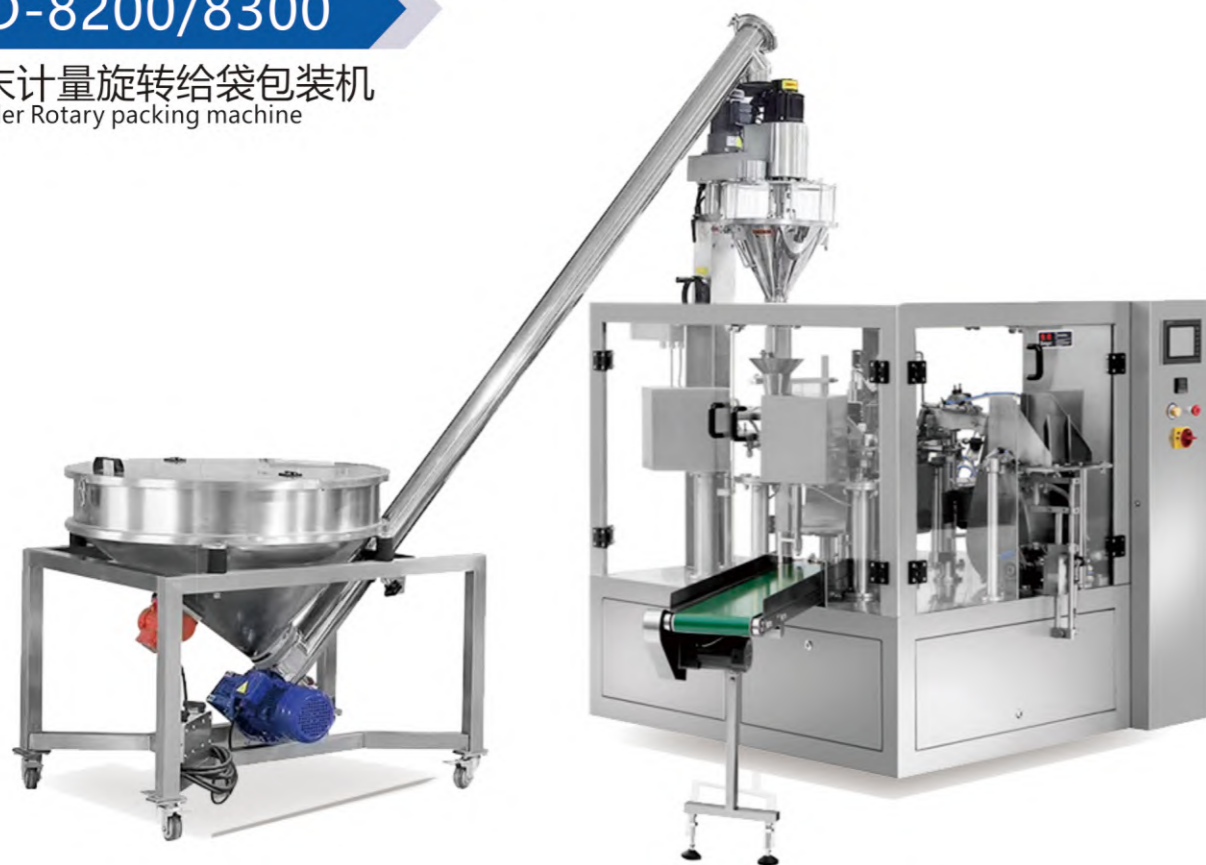

### (一) 常规机械组成

- |            |          |
|------------|----------|
| 1. 打码机     | 6. 电磁阀   |
| 2. PLC控制系统 | 7. 温控仪   |
| 3. 开袋装置    | 8. 真空泵   |
| 4. 振动装置    | 9. 变频器   |
| 5. 气缸      | 10. 输出系统 |

### (二) 主要性能和结构特点

- 快速更换包装袋的规格, 带宽大小一键自动调节。
- 单轴传动加内凸轮设计, 包装速度快, 运行更加稳定、维修更简单、减少次品率。
- 模块化加热、温控更精准、加热故障可报警提示。
- 先进的设计理念, 降低了包材耗损, 保证了设备运行的稳定性, 延长了设备的运行寿命。
- 操作简单方便, 采用先进的PLC+POD(触摸屏)电气控制系统, 人机界面友好。
- 机器的包装范围广泛, 可包装液体、酱体、颗粒、粉剂、固体各种可装袋物料, 只需根据不同的计量装置即可。
- 本机适用预制好的包装袋, 包装图案完美、封口品质好, 从而提高了产品的品质与档次。

### Mechanical components

- |                       |                           |
|-----------------------|---------------------------|
| 1. Code printer       | 6. electromagnetic valve  |
| 2. PLC control system | 7. Temperature controller |
| 3. bag opening device | 8. Vacuum pump            |
| 4. Vibration device   | 9. Inverter               |
| 5. Cylinder           | 10. Output system         |

### Feature

- Rapid change of the specifications of the bag, bag width can be automatically adjusted by one button.
- Single shaft and the CAM design: packaging speed faster; more stable operation; maintenance easier and reduce defective rate.
- Modular heating, temperature control more accurate, heating fault have alarm prompt.
- Advanced design idea, reduce the material loss, ensure the stability of equipment operation, extend the operating life of the equipment.
- Simple and convenient operation, adopts the advanced PLC+POD (touch screen) electric control system and man-machine interface.
- Machine have wide packaging range, it can packaging: liquid, paste, granule, powder, solid various bagging materials only. According to the different material with different metering device.
- Machine use preformed bags & packaging design is perfect & good sealing quality to improve the quality and grade of the product.

### (三) 技术参数 Specification

机器型号 (Type)	粉末计量旋转给袋包装机 (Powder Rotary packing machine)	
	LD8200	LD8300
包装袋型 (Bag Type)	三边封, 四边封袋, 自立袋, 手提袋、壶口袋、拉链袋、复合袋等 3-side, 4 side sealing bag, stand-up bag, handbag, spout bags, zipper bag, compound bag, etc.	
包装尺寸 (Bag Size)	W: 70-200mm	W: 200-300mm
充填范围 (Filling Range)	10/1000g	10-2500g
包装速度 (Packing Speed)	40~60包/分钟 (其速度由产品自身充填量决定) 25~40包/分钟 (拉链袋) 40~60bag/min (speed is determined by the product filling quantity) 25~40 bags/min (for zipper pouch)	30~40包/分钟 (速度由产品灌装量决定) 25~35包/分钟 (拉链袋) 30~40 bags/min (speed is determined by the product filling quantity) 25~35 bags/min (for zipper pouch)
计量平均精度 (Average Precision)	<±1%	
总功率 (Total Power)	2.5KW	4KW
工作流程 (Work Flow)	1.上袋 2.打印生产日期 3.开拉链 4.充分张开袋子 5.填充, 振动 (可选) 6.填充后产品通过振动积集 7.排气 (选项), 关闭拉链, 热封 8.整形及输出产品 1.giving bag 2.coding date(option) 3.open zipper 4.open the top and bottom 5.filling,vibrate(option) 6.The filling product is integrated by vibration 7.exhaust(option),closing zipper,sealing 8.forming and output	
外形尺寸 (Dimensions)	1900mm X 1570mm X 1700mm (L*W*H)	2450mm X 1750mm X 1450mm (L*W*H)

### 工作流程 Work Process

- |                                       |   |
|---------------------------------------|---|
| 1 上袋 (Giving bag)                     | 5 填充, 振动 (可选)<br>filling,vibrate(option)                        |
| 2 打印生产日期 (Coding date)                | 6 填充后产品通过振动积集<br>The filling product is integrated by vibration |
| 3 开拉链 (opening zipper)                | 7 排气 (选项), 关闭拉链, 热封<br>exhaust(option),closing zipper,sealing   |
| 4 充分张开袋子<br>(Open the top and bottom) | 8 整形及输出产品<br>Forming and output                                 |

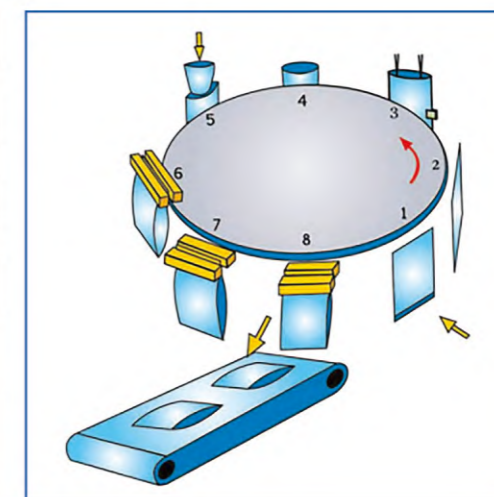
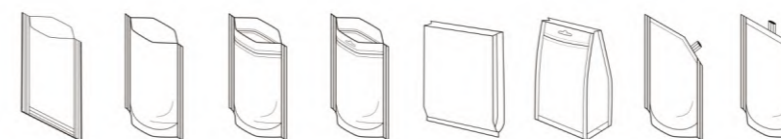

### (四) 适用范围

- 粉类: 奶粉、葡萄糖、味精、调味料、洗衣粉、化工原料、细白糖、农药、化肥等。

### Applications

- Powder type: milk powder, glucose, monosodium glutamate, seasoning, washing powder, chemical materials, fine white sugar, pesticide, fertilizer, etc.



# LD 系列旋转给袋包装机

## LD Series Rotary packaging machine

### LD-8200/8300

液体计量旋转给袋包装机  
Liquid Rotary Packing Machine



### (一) 常规机械组成

- |            |          |
|------------|----------|
| 1. 打码机     | 6. 电磁阀   |
| 2. PLC控制系统 | 7. 温控仪   |
| 3. 开袋装置    | 8. 真空泵   |
| 4. 振动装置    | 9. 变频器   |
| 5. 气缸      | 10. 输出系统 |

### Mechanical components

- |                       |                           |
|-----------------------|---------------------------|
| 1. Code printer       | 6. electromagnetic valve  |
| 2. PLC control system | 7. Temperature controller |
| 3. bag opening device | 8. Vacuum pump            |
| 4. Vibration device   | 9. Inverter               |
| 5. Cylinder           | 10. Output system         |

### (二) 主要性能和结构特点

- 快速更换包装袋的规格，带宽大小一键自动调节。
- 单轴传动加内凸轮设计，包装速度快，运行更加稳定、维修更简单、减少次品率。
- 模块化加热、温控更精准、加热故障可报警提示。
- 先进的设计理念，降低了包材损耗，保证了设备运行的稳定性，延长了设备的运行寿命。
- 操作简单方便，采用先进的PLC+POD(触摸屏)电气控制系统，人机界面友好。
- 机器的包装范围广泛，可包装液体、酱体、颗粒、粉剂、固体各种可装袋物料，只需根据不同的计量装置即可。
- 本机适用预制好的包装袋，包装图案完美、封口品质好，从而提高了产品的品质与档次。

### Feature

- Rapid change of the specifications of the bag, bag width can be automatically adjusted by one button.
- Single shaft and the CAM design: packaging speed faster; more stable operation; maintenance easier and reduce defective rate.
- Modular heating, temperature control more accurate, heating fault have alarm prompt.
- Advanced design idea, reduce the material loss, ensure the stability of equipment operation, extend the operating life of the equipment.
- Simple and convenient operation, adopts the advanced PLC+POD (touch screen) electric control system and man-machine interface.
- Machine have wide packaging range, it can packaging: liquid, paste, granule, powder, solid various bagging materials only. According to the different material with different metering device.
- Machine use preformed bags & packaging design is perfect & good sealing quality to improve the quality and grade of the product.

### (三) 技术参数 Specification

机器型号 (Type)	液体计量旋转给袋包装机 (Liquid Rotary Packing Machine)	
	LD8200	LD8300
包装袋型 (Bag Type)	三边封, 四边封袋, 自立袋, 手提袋、壶口袋、拉链袋、复合袋等 3-side, 4 side sealing bag, stand-up bag, handbag, spout bags, zipper bag, compound bag, etc.	
包装尺寸 (Bag Size)	W: 70-200mm	W: 200-300mm
充填范围 (Filling Range)	10/1000g	10-2500g
包装速度 (Packing Speed)	40~60包/分钟 (其速度由产品自身充填量决定) 25~40包/分钟 (拉链袋) 40~60bag/min (speed is determined by the product filling quantity) 25~40 bags/min (for zipper pouch)	30~40包/分钟 (速度由产品灌装量决定) 25~35包/分钟 (拉链袋) 30~40 bags/min (speed is determined by the product filling quantity) 25~35 bags/min (for zipper pouch)
计量平均精度 (Average Precision)	<±1%	
总功率 (Total Power)	2.5KW	4KW
工作流程 (Work Flow)	1.上袋 2.打印生产日期 3.开拉链 4.充分张开袋子 5.填充, 振动 (可选) 6.填充后产品通过振动聚集 7.排气 (选项), 关闭拉链, 热封 8.整形及输出产品 1.giving bag 2.coding date(option) 3.open zipper 4.open the top and bottom 5.filling,vibrate(option) 6. The filling product is integrated by vibration 7.exhaust(option),closing zipper,sealing 8. forming and output	
外形尺寸 (Dimensions)	1900mm X 1570mm X 1700mm (L*W*H)	2450mm X 1750mm X 1450mm (L*W*H)

### 工作流程 Work Process

- |                                       |   |
|---------------------------------------|---|
| 1 上袋 (Giving bag)                     | 5 填充, 振动 (可选)<br>filling,vibrate(option)                        |
| 2 打印生产日期 (Coding date)                | 6 填充后产品通过振动聚集<br>The filling product is integrated by vibration |
| 3 开拉链 (opening zipper)                | 7 排气 (选项), 关闭拉链, 热封<br>exhaust(option),closing zipper,sealing   |
| 4 充分张开袋子<br>(Open the top and bottom) | 8 整形及输出产品<br>Forming and output                                 |

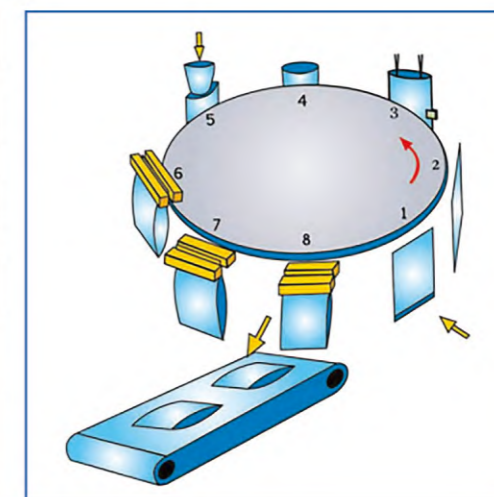
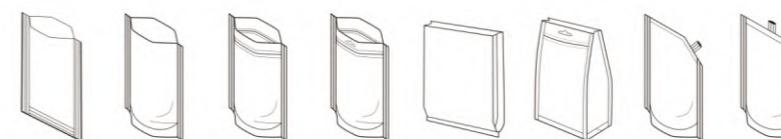

### (四) 适用范围

- 液体/糊状: 洗涤剂、米酒、酱油、米醋、果汁、饮料、番茄酱、花生酱、果酱、辣椒酱、豆沙。

### Applications

- Liquid/paste type: detergent, rice wine, soy sauce, rice vinegar, fruit juice, beverage, tomato sauce, peanut butter, jam, chili sauce, bean paste.



# LDB 系列单工位预制袋包装机

LDB Series Single Station Preformed Pouch Packing Machine

LDB-200/300/430

组合称量单工位给袋颗粒包装机  
Granule Packing Machine with Combination Weigher

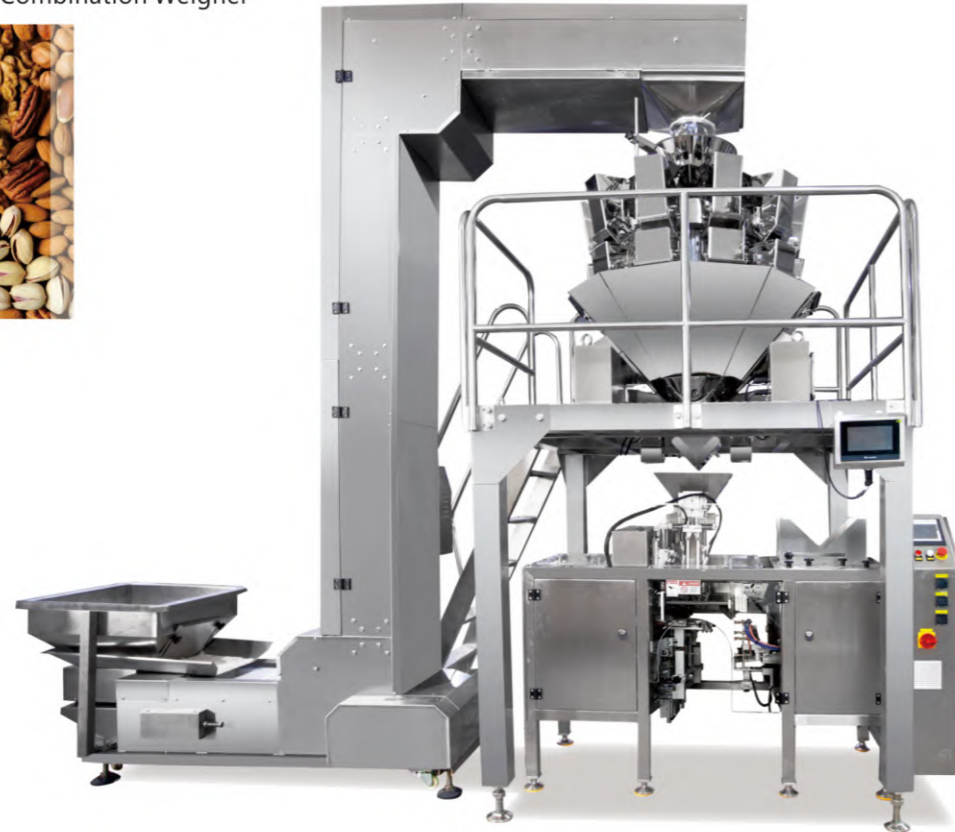

## (一) 常规机械组成

1. 触摸屏
2. PLC控制系统
3. 气缸
4. 温度控制器
5. 存袋器
6. 夹袋器
7. 下料斗
8. 开袋器

## (二) 辅助功能装置(选配)

1. 拉链开
2. 保护夹子
3. 真空泵

## (三) 主要性能和机构特点

- 本机器专门为各类复合膜预制袋的包装应用研制;
- PLC和人机界面控制,方便参数设定和故障排除;
- 应用不同袋大小,调整简单,无需工具;
- 智能控温配置,封口美观、整齐;
- 省袋设计,无完全打开袋,无灌装和封口;
- 粉体、颗粒、液体配比兼容程序,即插即用,方便不同产品切换
- 门打开机器即停止运作。

## Standard Equipment Parts:

1. The couch screen
2. PLC control system
3. Cylinder
4. Temperature controller
5. bag depositor
6. Bag gripper
7. Bag hopper
8. Pouch opening devices

## Auxiliary function device (optional):

1. zipper opener
2. protect the clip
3. vacuum pump

## Standard Features

- Machine is specially developed for all kinds of composite pre-made bags.
- PLC & HMI Control , Easy for parameter setting and troubleshooting.
- Different pouch size adaption, simple adjustment without tools.
- Intelligent temperature controlling configuration, ensure the artistic and neat sealing.
- Pouch saving design, no completely opened pouch, no filling and sealing.
- Compatible Programs of powder, granule or liquid dosing, easy for different products switching.
- Machine stoped when the door is opened.

## 单工位给袋粉末包装机 Powder Packing Machine



## 单工位液体给袋包装机 Liquid Packing Machine



## (四) 可选功能

- 小袋拉链开启功能;
- 风琴袋开启功能;
- 气冲功能,保持产品新鲜,避免产品破损;
- 空气/氮气充、放气功能;
- 真空功能,保持产品新鲜,减少包装空间;
- 抽袋机振动压实功能,使产品落到袋底,提高包装密度;
- 夹持密封,以避免粉末在灌装过程中出来;
- 设有除尘装置,使包装环境清洁,确保封口质量;
- 不同类型码印功能,热印色带打印机、喷墨打印机、热转印打印机等。

## Optional Features

- Pouch zipper opening function.
- Gusset pouch opening function.
- Gas flush function to keep the products fresh and avoid them broken.
- Air/Nitrogen Inflating, Air deflating function.
- Vacuum function to keep the products fresh and reduce the package space.
- Bag tapper vibrating compacting function help products drop to the bag bottom part and enhance packaging density.
- Grip seal to avoid powders coming out during filling.
- Dedusting device to enable clean packaging environment and ensure quality of sealing.
- Different types of code printing function, such as hot stamp ribbon printer, inkjet printer, thermal transfer printer and so on.

### (五) 技术参数 Specification

机器型号 (Type)	LDB-200	LDB-300	LDB-430
包装材料 (Bag Material)	多层复合预制袋 Multi-layer Composite Premade Bag (e.g.: PET/PE)		
适用袋型 (Premade bag type)	三边封袋、自立袋 (3-sides sealing bag, stand-up bag)		
可升级袋型 (Upgraded Bag Type)	无可升级的袋型 (Need additional purchase of functional device)	插角袋、拉链袋、盒形袋 (需额外购买功能装置) Gusset Bag, Zipper Bag, box bag (Need additional purchase of functional device)	
包装尺寸 (Bag size)	70mm≤W≤150mm 70mm≤L≤150mm	80mm≤W≤300mm 100mm≤L≤300mm	80mm≤W≤300mm 100mm≤L≤430mm
速度 (Speed)	0-60bags/min		
封口类型 (Sealing Type)	直纹, 齿距1mm (可选网纹) Straight grain, pitch is 1mm (Optional reticulate)		
封口宽度 (Sealing Width)	10mm (5--20mm)可订做 can be customized		
电压 (Voltage)	220V, 单相, 50/60HZ, 1.2KW (220V, Single-phase, 50/60HZ, 1.2KW)		
气压 (Air Pressure)	0.65Mpa		
耗气量 (Air Consumption)	0.3m <sup>3</sup> /min标准机, 不含附加功能 (Standard machine, no additional function)		
机器尺寸 (Body Dimension)	1770*600*1230mm	1770*600*1360mm	
包装尺寸 (Packing Dimension)	1860*710*1550mm	1860*710*1650mm	
	免熏蒸出口木箱 (Export non-fumigation wooden case)		

### (六) 适用范围 Application

Landpack单工位预成型袋包装机适用于将粉状、颗粒状或液体灌装入预成型袋并封口，具体应用说明如下表：  
Landpack single station preformed pouch packing machine is applicable for dosing powder, granule or liquid into a premade pouch and sealing, the detail application description as following table:

适用 Application	应用说明 Application Description
适用袋型 Applicable Pouches	复合热封预制袋, 如扁平袋, 风琴袋, 自立袋, 或自立拉链袋等 Laminate heat sealable premade pouches like flat pouch, gusset pouch, normal stand up pouch, or stand up pouch with zipper etc
适用产品 Applicable Products	配置不同的灌装装置, 可灌装液体、粉末、颗粒或其他不规则固体物料。 Configure with different dosing devices, capable to pack with liquid, powder, granule, or other irregular solid materials.
适用包装材料 Applicable Packaging Material	OPP/PE、BOPP/OPP/PE、PET/AL等复合热密封包装材料 Laminate Heat sealable packing materials such as OPP/PE, BOPP/OPP/PE, PET/AL etc

### (七) 包装样袋 Packing Examples



## LDB 系列单工位预制袋包装机 LDB Series Single Station Preformed Pouch Packing Machine

### LDB-600



#### (一) 常规机械组成

1. 触摸屏
2. PLC控制系统
3. 气缸
4. 温度控制器
5. 存袋器
6. 夹袋器
7. 下料斗
8. 开袋器

#### (二) 辅助功能装置(选配)

1. 拉链开
2. 保护夹子
3. 真空泵

#### (三) 主要性能和机构特点

- 本机器专门为各类复合膜预制袋的包装应用研制;
- PLC和人机界面控制, 方便参数设定和故障排除;
- 应用不同袋大小, 调整简单, 无需工具;
- 智能控温配置, 封口美观、整齐;
- 省袋设计, 无完全打开袋, 无灌装和封口;
- 粉体、颗粒、液体配比兼容程序, 即插即用, 方便不同产品切换
- 门打开机器即停止运作。

#### Standard Equipment Parts:

1. The touch screen
2. PLC control system
3. Cylinder
4. Temperature controller
5. bag depositor
6. Bag gripper
7. Bag hopper
8. Pouch opening devices

#### Auxiliary function device (optional):

1. zipper opener
2. protect the clip
3. vacuum pump

#### Standard Features

- Machine is specially developed for all kinds of composite pre-made bags.
- PLC & HMI Control, Easy for parameter setting and troubleshooting.
- Different pouch size adaption, simple adjustment without tools.
- Intelligent temperature controlling configuration, ensure the artistic and neat sealing.
- Pouch saving design, no completely opened pouch, no filling and sealing.
- Compatible Programs of powder, granule or liquid dosing, easy for different products switching.
- Machine stoped when the door is opened.



#### (四) 可选功能

- 小袋拉链开启功能;
- 风琴袋开启功能;
- 气冲功能,保持产品新鲜,避免产品破损;
- 空气/氮气充、放气功能;
- 真空功能,保持产品新鲜,减少包装空间;
- 抽袋机振动压实功能,使产品落到袋底,提高包装密度;
- 夹持密封,以避免粉末在灌装过程中出来;
- 设有除尘装置,使包装环境清洁,确保封口质量;
- 不同类型码印功能,热印色带打印机、喷墨打印机、热转印打印机等。

#### Optional Part:

- zipper opening.
- Gusset pouch opening.
- Gas flush function to keep the product fresh and avoid breaking.
- Air/Nitrogen Inflating, Air deflating function.
- Vacuum function to keep the products fresh and reduce the package space.
- The vibrating bag tapper function to make product fill into bottom of bag and enhance the sealing density.
- Grip seal to avoid powder coming out during filling.
- Dedusting device to keep clean packaging environment and ensure quality of sealing.
- Different types of code printing function, such as ribbon printer, inkjet printer, thermal transfer printer and so on.

#### (五) 技术参数 Specification

机器型号 (Type)	LDB-600
包装材料 (Bag Material)	多层复合预制袋 Multi-layer Composite Premade Bag (e.g.: PET/PE)
适用袋型 (Premade bag type)	三边封袋、自立袋 (3-sides sealing bag, stand-up bag)
可升级袋型 (Upgraded Bag Type)	插角袋、拉链袋、盒形袋 (需额外购买功能装置) Gusset Bag, Zipper Bag, box bag (Need additional purchase of functional device)
包装尺寸 (Bag size)	250mm ≤ W ≤ 500mm; 380mm ≤ L ≤ 600mm
速度 (Speed)	0~10bags/min
封口类型 (Sealing Type)	直纹, 齿距1mm (可选网纹) Straight grain, pitch is 1mm (Optional reticulate)
封口宽度 (Sealing Width)	10mm (5--20mm)可订做 can be customized
电压 (Voltage)	220V,单相,50/60HZ,2KW (220V, Single-phase,50/60HZ, 2KW)
气压 (Air Pressure)	0.65Mpa
耗气量 (Air Consumption)	0.4m <sup>3</sup> /min标准机, 不含附加功能 (Standard machine, no additional function)
机器尺寸 (Body Dimension)	1677*1140*1450mm
包装尺寸 (Packing Dimension)	1780*1250*1750mm
	免熏蒸出口木箱 (Export non-fumigation wooden case)

#### (六) 适用范围 Application

Landpack单工位预成型袋包装机适用于将粉状、颗粒状或液体灌装入预成型袋并封口, 具体应用说明如下表:

Landpack single station doypack machine is suitable for powder, granule or liquid into a premade pouch and sealing .The details as following:

适用 Application	应用说明 Application Description
适用袋型 Applicable Pouches	复合热封预制袋,如扁平袋,风琴袋,自立袋,或自立拉链袋等 Laminate heat sealable premade pouches like flat pouch, gusset pouch, normal stand up pouch, or stand up pouch with zipper etc
适用产品 Applicable Products	配置不同的灌装装置,可灌装液体、粉末、颗粒或其他不规则固体物料。 Configure with different dosing devices, capable to pack with liquid, powder, granule, or other irregular solid materials.
适用包装材料 Applicable Packaging Material	OPP/PE、BOPP/OPP/PE、PET/AL等复合热密封包装材料 Laminate Heat sealable packing materials such as OPP/PE,BOPP/OPP/PE, PET/AL etc

#### (七) 包装样袋 Packing Examples



## 水平给袋包装机

Horizontal Doypack packing machine

LDSP-160/160异形袋/210

粉末水平给袋包装机  
Powder doypack packing machine



#### (一) 常规机械组成

- 1.触摸屏
- 2.打印机
- 3.变频器
- 4.温控仪
- 5.真空开袋装置
- 6.送袋装置
- 7.光电检测元件
- 8.PLC控制系统
- 9.输出装置

#### Mechanical components

- 1.Touch screen
2. Code printer
3. Inverter
4. Temperature controller
5. Vacuum bag opening device
6. Bag feeder
7. photoelectric detection sensor
8. PLC control system
9. Bag outputter



## (二) 主要性能和结构特点

- 放袋槽放袋方便简单, 配备自动压袋装置;
- 配置进口压力感应装置, 达到不下料不封的效果, 节约包装袋;
- 采用彩色触摸式显示屏, 简单操作, 多功能设计;
- 机器采用不锈钢304 外观, 部分配件做耐酸、耐盐防腐处置层加工。
- 选材要求: 大部分配件以模具化生产成型, 主要材料选用304不锈与氧化铝。
- 可选配各种打码、喷码、排气、冲孔系统;

## (三) 适用范围

- 粉型: 奶粉、葡萄糖、味精、调味品、洗衣粉、化学原料、细白糖、农药、肥料等。

## (四) 技术参数 Specification

机器型号 (Type)	粉末计量旋转给袋包装机 (Powder Rotary packing machine)		
	LDSP-160	LDSP-160异形袋	LDSP-210
包装袋型 (Bag Type)	三边封, 四边封袋, 自立袋, 手提袋、壶口袋、拉链袋、复合袋等 3-side, 4 side sealing bag, stand-up bag, handbag, spout bags, zipper bag, compound bag, etc.		
包装尺寸 (Bag Size)	110-230mm*80-160mm(L*W)	70-100mm*110-230(L*W)	100-210mm/110-320mm (L*W)
填充范围 (Filling Range)	10g-100g	10g-100g	10g-1kg
包装速度 (Packing Speed)	20-45袋/分钟 (速度由产品填充量定) 20-45bags/min(speed is determined by the product filling quantity)	5-50袋/分钟 (速度由产品填充量定) 5-50bags/min(speed is determined by the product filling quantity)	20-50袋/分钟 (速度由产品填充量定) 20-50bags/min (speed is determined by the product filling quantity)
机器重量 (Machine weight)	800KG	800KG	900KG
总功率 (Total Power)	2.0KW	2.0KW	2.0KW
工作流程 (Work Flow)	1.取袋 2.拿袋(打码) 3.上下开袋 4.下料 5.热封 6.输出产品 1.Giving bag 2. Pick up the bag(coding) 3.Open the bag up and down 4.Filling 5.Heating sealing 6.Output of product		
外形尺寸 (Dimensions)	1750mm X 1285mm X 1360mm(L*W*H)		2140mm X 1366mm X 1360mm(L*W*H)
给袋机搭配组合 (Collocation)	螺杆计量机, 螺杆提升机. (Screw metering, screw elevator)		

### 工作流程 Work Process

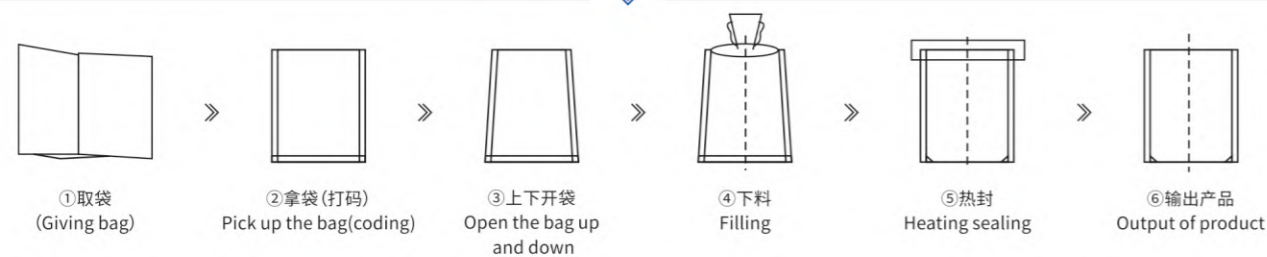

## (五) 包装样袋 Packing Examples



## Feature

- The bag feeder is easy to place the bags with pressing-bag accessory.
- It's with imported gravity sensor to read whether there is product there. No product, not seal to save bag.
- With color touch screen for simple operation.
- The machine adopts Stainless steel 304 appearance, and some accessories are processed with acid and salt-resistant anti-corrosion treatment layer.
- Majority of accessories will use 304 stainless steel and aluminium oxide;
- Optional accessories: inkjet printer, thermal printer, exhaust air, punching and ect.

## Applications

- Liquid/paste type: detergent, rice wine, soy sauce, rice vinegar, fruit juice, beverage, tomato sauce, peanut butter, jam, chili sauce, bean paste, Shampoo, hair cream.

# 水平给袋包装机

## Horizontal Doypack packing machine

### LDSP-160/160异形袋/210

## 液体水平给袋包装机 Liquid doypack packing machine



## (一) 常规机械组成

1. 触摸屏
2. 打印机
3. 变频器
4. 温控仪
5. 真空开袋装置
6. 送袋装置
7. 光电检测元件
8. PLC控制系统
9. 输出装置

## Mechanical components

1. Touch screen
2. Code printer
3. Inverter
4. Temperature controller
5. Vacuum bag opening device
6. Bag feeder
7. photoelectric detection sensor
8. PLC control system
9. Bag outputter



## (二) 主要性能和结构特点

- 放袋槽放袋方便简单, 配备自动压袋装置;
- 配置进口压力感应装置, 达到不下料不封的效果, 节约包装袋;
- 采用彩色触摸式显示屏, 简单操作, 多功能设计;
- 机器采用不锈钢304 外观, 部分配件做耐酸、耐盐防腐处理层加工。
- 选材要求: 大部分配件以模具化生产成型, 主要材料选用304不锈与氧化铝。
- 可选配各种打码、喷码、排气、冲孔系统;

## (三) 适用范围

- 液糊类型: 洗涤剂、米酒、酱油、米醋、果汁、饮料、番茄酱、花生酱、果酱、辣椒酱、豆酱。

## (四) 技术参数 Specification

机器型号 (Type)	液体水平给袋包装机Liquid doypack packing machine		
	LDSP-160	LDSP-160异形袋	LDSP-210
包装袋型 (Bag Type)	三边封, 四边封袋, 自立袋, 手提袋、壶口袋、拉链袋、复合袋等 3-side, 4 side sealing bag, stand-up bag, handbag, spout bags, zipper bag, compound bag, etc.		
包装尺寸 (Bag Size)	110-230mm*80-160mm(L*W)	70-100mm*110-230(L*W)	100-210mm/110-300mm (L*W)
填充范围 (Filling Range)	10-100ml	10-200ml	10-1000ml
包装速度 (Packing Speed)	20-45袋/分钟 (速度由产品填充量定) 20-45bags/min(speed is determined by the product filling quantity)	5-50袋/分钟 (速度由产品填充量定) 5-50bags/min(speed is determined by the product filling quantity)	10-45袋/分钟 (速度由产品填充量定) 10-45bags/min (speed is determined by the product filling quantity)
机器重量 (Machine weight)	800KG	800KG	900KG
总功率 (Total Power)	2.5KW	2.0KW	2.5KW
工作流程 (Work Flow)	1.取袋 2.拿袋(打码) 3.上下开袋 4.下料 5.热封 6.输出产品 1.Giving bag 2. Pick up the bag(coding) 3.Open the bag up and down 4.Filling 5.Heating sealing 6.Output of product		
外形尺寸 (Dimensions)	1750mm x 1285mm x 1360mm(L*W*H)		2140mm x 1366mm x 1360mm(L*W*H)
给袋机搭配组合 (Collocation)	液体计量泵 (Liquid metering pump)		

### 工作流程 Work Process

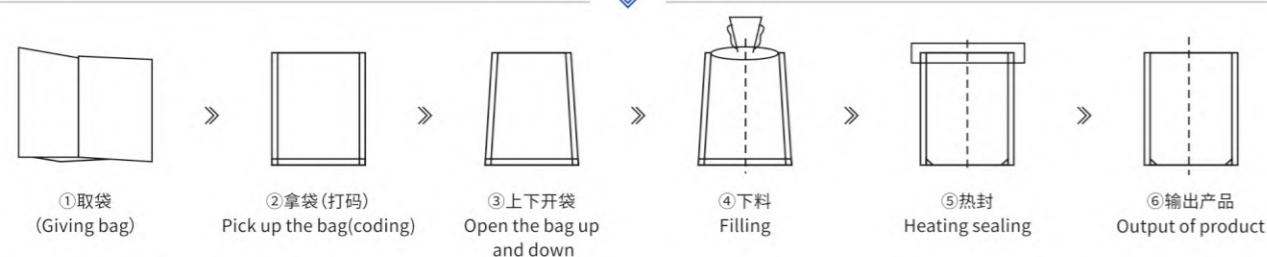

## (五) 包装样袋 Packing Examples



## Feature

- The bag feeder is easy to place the bags with pressing-bag accessory.
- It's with imported gravity sensor to read whether there is product there .No product , not seal to save bag.
- With color touch screen for simple operation.
- The machine adopts Stainless steel 304 appearance, and some accessories are processed with acid and salt-resistant anti-corrosion treatment layer.
- Majority of accessories will use 304 stainless steel and aluminium oxide ;
- Optional accessories : inkjet printer , thermal printer , exhaust air , punching and ect .

## Applications

- Liquid/paste type: detergent, rice wine, soy sauce, rice vinegar, fruit juice, beverage, tomato sauce, peanut butter, jam, chili sauce, bean paste.

# 水平给袋包装机

## Horizontal Doypack packing machine

### LDSP-160/160异形袋/210

## 颗粒水平给袋包装机 Granule doypack packing machine



## (一) 常规机械组成

- 1.触摸屏
- 2.打印机
- 3.变频器
- 4.温控仪
- 5.真空开袋装置
- 6.送袋装置
- 7.光电检测元件
- 8.PLC控制系统
- 9.输出装置

## Mechanical components

- 1.Touch screen
2. Code printer
3. Inverter
4. Temperature controller
5. Vacuum bag opening device
- 6.Bag feeder
- 7.photoelectric detection sensor
- 8.PLC control system
- 9.Bag outputter



## (二) 主要性能和结构特点

- 放袋槽放袋方便简单, 配备自动压袋装置;
- 配置进口压力感应装置, 达到不下料不封的效果, 节约包装袋;
- 采用彩色触摸式显示屏, 简单操作, 多功能设计;
- 机器采用不锈钢304 外观, 部分配件做耐酸、耐盐防腐处置层加工。
- 选材要求: 大部分配件以模具化生产成型, 主要材料选用304不锈与氧化铝。
- 可选配各种打码、喷码、排气、冲孔系统;

## (三) 适用范围

- 块料: 豆腐、蛋糕、鱼、鸡蛋、糖果、红枣、谷物、巧克力、饼干、花生等
- 颗粒类型: 结晶味精、颗粒药物、胶囊、种子、化学品、糖、鸡精、甜瓜、坚果、农药、肥料。

## (四) 技术参数 Specification

机器型号 (Type)	颗粒水平给袋包装机 (Granule doypack packing machine)		
	LDSP-160	LDSP-160异形袋	LDSP-210
包装袋型 (Bag Type)	三边封, 四边封袋, 自立袋, 手提袋、壶口袋、拉链袋、复合袋等 3-side, 4 side sealing bag, stand-up bag, handbag, spout bags, zipper bag, compound bag, etc.		
包装尺寸 (Bag Size)	110-230mm*80-160mm(L*W)	70-100mm*110-230(L*W)	100-210mm/110-320mm (L*W)
填充范围 (Filling Range)	20g-500g	20g-500g	20g-1000g
包装速度 (Packing Speed)	20-45袋/分钟 (速度由产品填充量定) 20-45bags/min (speed is determined by the product filling quantity)		20-50袋/分钟 (速度由产品填充量定) 20-50bags/min (speed is determined by the product filling quantity)
机器重量 (Machine weight)	800KG	800KG	900KG
总功率 (Total Power)	2.5KW	2.0KW	2.5KW
工作流程 (Work Flow)	1.取袋 2.拿袋(打码) 3.上下开袋 4.下料 5.热封 6.输出产品 1.Giving bag 2. Pick up the bag(coding) 3.Open the bag up and down 4.Filling 5.Heating sealing 6.Output of product		
外形尺寸 (Dimensions)	1750mm X 1285mm X 1360mm(L*W*H)		2140mm X 1366mm X 1360mm(L*W*H)
给袋机搭配组合 (Collocation)	组合称, 线性称, Z-型提升机(Multi-head weigher, linear scale, Z-type elevator)		

### 工作流程 Work Process

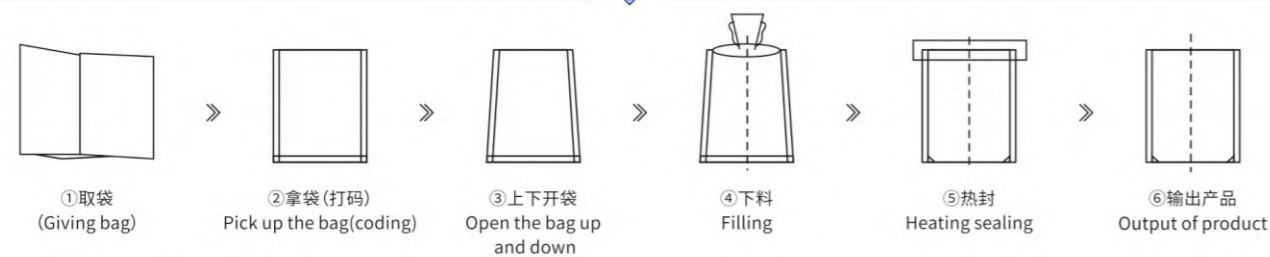

## (五) 包装样袋 Packing Examples



## Feature

- The bag feeder is easy to place the bags with pressing-bag accessory.
- It's with imported gravity sensor to read whether there is product there .No product , not seal to save bag.
- With color touch screen for simple operation.
- The machine adopts Stainless steel 304 appearance, and some accessories are processed with acid and salt-resistant anti-corrosion treatment layer.
- Majority of accessories will use 304 stainless steel and aluminium oxide ;
- Optional accessories : inkjet printer , thermal printer , exhaust air , punching and ect .

## Applications

- Block type: tofu,bread and cake, fish, eggs, candy, red jujube, cereal, chocolate, biscuit, peanut, etc.
- Granular type: crystal monosodium glutamate, granular drug, capsule, seeds, chemicals, sugar, chicken essence, melon seeds, nut, pesticide, fertilizer.

# LDSP-140S双给袋水平包装机

## LDSP-140S Horizontal Double Doypack packing machine

### 液体水平双给袋包装机 Liquid doypack packing machine



### 粉末水平双给袋包装机 Powder doypack packing machine

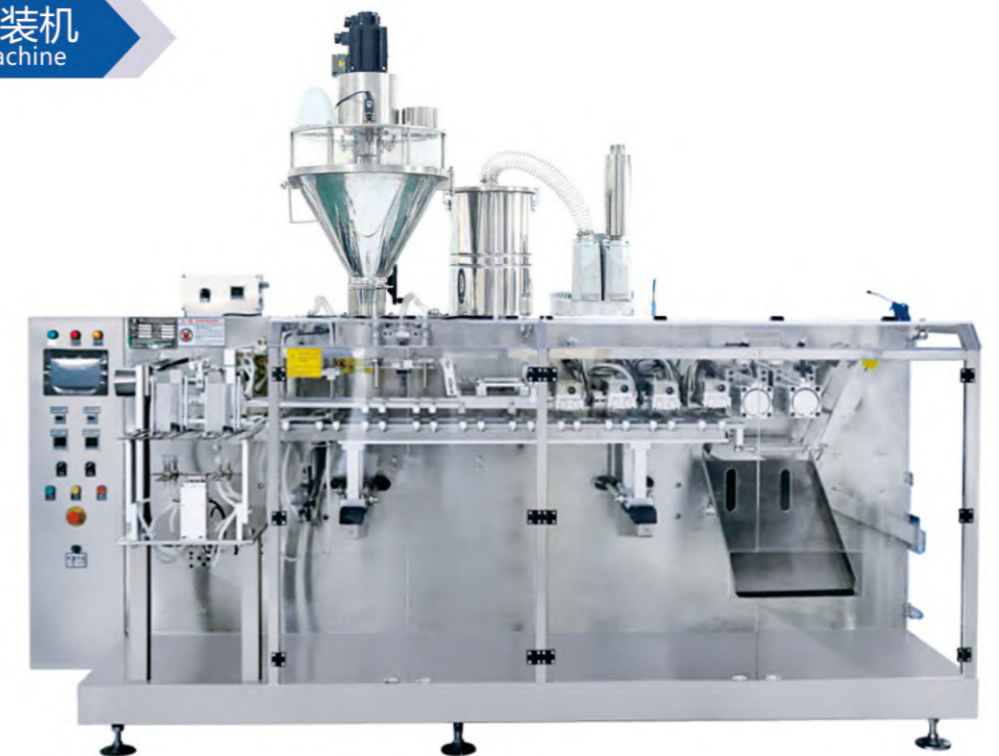

## 颗粒水平双给袋包装机 Granule horizontal dual doypack machine



### (一) 常规机械组成

1. 触摸屏
2. 打印机
3. 变频器
4. 温控仪
5. 真空开袋装置
6. 送袋装置
7. 光电检测元件
8. PLC控制系统
9. 输出装置

### (二) 主要性能和结构特点

- 放袋槽放袋方便简单, 配备自动压袋装置;
- 配置进口压力感应装置, 达到不下料不封的效果, 节约包装袋;
- 采用彩色触摸式显示屏, 简单操作, 多功能设计;
- 机器采用不锈钢304L外观, 碳钢机架部分与部分配件做耐酸、耐盐防腐处置层加工。
- 选材要求: 大部分配件以模具化生产成型, 主要材料选用304不锈钢与氧化铝。
- 可选配各种打码、喷码、排气、冲孔系统;

### Mechanical components

1. Touch screen
2. Code printer
3. Inverter
4. Temperature controller
5. Vacuum bag opening device
6. Bag feeder
7. photoelectric detection sensor
8. PLC control system
9. Bag outputer

### Feature

- The bag-feeding slot is convenient and simple to place bags, and is equipped with an automatic bag-pressing device.
- It is equipped with an imported pressure sensing device to achieve no blanking or sealing .
- Use color touch screen, simple operation, multi-functional design.
- The machine adopts stainless 304L appearance, and the carbon steel frame part and some accessories are processed with acid and salt resistant anti-corrosion treatment layer.
- Material selection requirements: Most of the accessories are formed by mold production, and the main materials are 304 stainless steel and alumina.
- Various coding, coding, exhaust, and punching systems are optional.

### (三) 适用范围

- 块料: 豆腐、蛋糕、鱼、鸡蛋、糖果、红枣、谷物、巧克力、饼干、花生等。
- 颗粒类型: 结晶味精、颗粒药物、胶囊、种子、化学品、糖、鸡精、甜瓜、坚果、农药、肥料等。
- 粉型: 奶粉、葡萄糖、味精、调味品、洗衣粉、化学原料、细白糖、农药、肥料等。
- 糊类型: 洗涤剂、米酒、酱油、米醋、果汁、饮料、番茄酱、花生酱、果酱、辣椒酱、豆酱、洗发水、发膏。
- 泡菜、腌菜、泡菜、萝卜等。

### (四) 技术参数 Specification

机器型号 (Type)	LDSP-140S双给袋水平包装机 (Horizontal Double Doypack packing machine)		
	颗粒包装 (Granule packing)	液体包装 (Liquid packing)	粉末包装 (Powder packing)
包装袋型 (Bag Type)	三边封, 四边封袋, 自立袋, 手提袋、壶口袋、拉链袋、复合袋等 3-side, 4 side sealing bag, stand-up bag, handbag, spout bags, zipper bag, compound bag, etc.		
包装尺寸 (Bag Size)	100-250mm/90-140mm(L*W)	100-250mm/90-140mm(L*W)	100-250mm/90-140mm(L*W)
填充范围 (Filling Range)	20g-1000g	10g-1kg	10g-1kg
包装速度 (Packing Speed)	20-50袋/分钟 (速度由产品填充量定) 20-50bags/min (speed is determined by the product filling quantity)	10-45袋/分钟 (速度由产品填充量定) 10-45bags/min (speed is determined by the product filling quantity)	20-50袋/分钟 (速度由产品填充量定) 20-50bags/min (speed is determined by the product filling quantity)
机器重量 (Machine weight)	900KG	900KG	900KG
总功率 (Total Power)	2.5KW	2.5KW	2.0KW
工作流程 (Work Flow)	1.取袋 2.拿袋(打码) 3.上下开袋 4.下料 5.热封 6.输出产品 1.Giving bag 2. Pick up the bag(coding) 3.Open the bag up and down 4.Filling 5.Heating sealing 6.Output of product		
外形尺寸 (Dimensions)	2140mm x 1366mm x 1360mm(L*W*H)		
给袋机搭配组合 (Collocation)	组合称, 线性称, Z-型提升机 Multi-head weigher, linear scale	液体计量泵 Liquid metering pump	螺杆计量机, 螺杆提升机 Screw metering, screw elevator

### 工作流程 Work Process

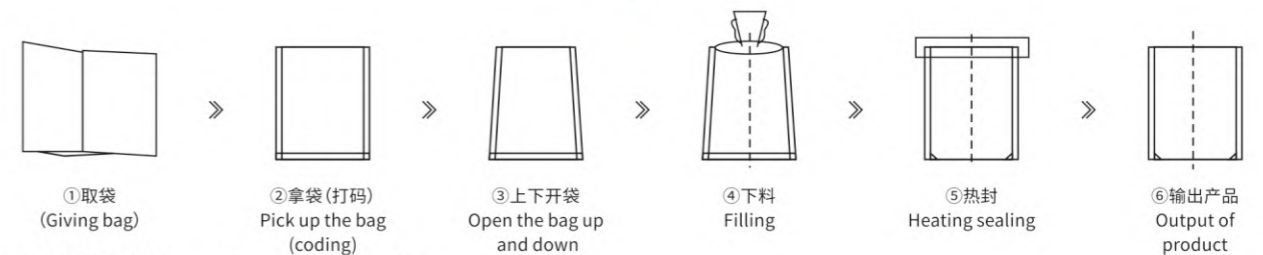

### (五) 包装样袋 Packing Examples



## 多头电脑组合称量称

Combination balance with multi computer computer



十头电脑组合秤  
(10 heads weigher)



十四头电脑组合秤  
(14 heads weigher)



二十四头电脑组合秤  
(24 heads weigher)

### (一) 主要性能和结构特点

- 全新设计，亮丽外观，结构更合理，技术更先进。
- 高精度高速度的完美结合通过电脑计算从丰富的重量组合中瞬间选出最佳组合，高精度数字式传感器使准确计量瞬间得以实现中 / 英文液晶显示屏操作系统。
- 防水防尘式设计，所有部件采用不锈钢，干净卫生。全密封设计防止了物料的堆积且清扫方便。
- 能根据被计量物的特性，细微调整料斗门的开闭速度，防止破碎及卡料。
- 自我诊断功能。兼容性强，直接安装在包装机上方。结构更为紧凑。
- 为您节省大量原材料与劳动力成本，投资回报快。

### (二) 适用范围

- 糖果、瓜子、薯片、开心果、花生、果仁、果脯、果冻、冷冻汤圆、饼干、蜜饯、樟脑丸、葡萄干、杏仁、巧克力、榛子、谷物、宠物食品、膨化食品、五金件、塑料件等各种颗粒状、片状、条状、不规则形状物料的定量称重。

### (三) 技术规格 Specifications

机 型 (Type)	LD-8	LD-10	LD-12	LD-14	LD-16
计量头数 (Measuring head)	8	10	12	14	16
单次称量 (Single weighing range)	10-600g	10-1000g	10-1000g	10-2000g	10-1000g
称量精度 (Accuracy)	±0.3-1.5g				
称量速度 (Weighing speed)	60bag/min	70bag/min	100bag/min	120bag/min	180bag/min
料斗容量 (Hopper volume)	1300ml		1700ml	1300ml	1300ml
料斗形式 (Bucket type)	双排无记忆斗 (double row unrecorded bucket)		单排斗 (single row bucket)	双排无记忆斗 (double row unrecorded bucket)	
产品预设模式 (Product preset mode)	99种				
控制元件 (Control element)	荧光显示管 (256X64点5.7寸) Fluorescent light display tube(256*64pixel)			10.4寸液晶触摸屏 10.4LCD display tube	

### Feature

- Combining the hi-precision and hi-rate can vote in the best compounding from the abundant weight compounding by computerizing. Hi-rate digital sensor can give in a short time.
- Operation system of LCD with Chinese-English .
- All the parts adopt the stainless with clean and sanitation by the design of waterproof and dustproof. Design of complete airproof can prevent the material stacking and ease to clean.
- To adjust slightly the rate of the hopper door to avoid crashing and blocking the material.
- Self-diagnosis function.
- To fix directly above the packing machine and the structure is more close with better compatibility.
- To save a lot of raw material and the cost of labour force and get the return quickly.

### Applications

- All kinds of grain material, sheet material, strip material and abnormality material which such as candy, melon seeds, chips, peanut, nutlet, preserved fruit, jelly, biscuit, confect, camphorball, currant, almond, chocolate, filbert, cornpet foodstuff, dilatant foodstuff, hardware and plastic can be weighed by the ration.

## 四斗称

Balance with four hopper

### (一) 主要性能和结构特点

- 数字式传感器使精确计量瞬间得以实现。
- 微电脑控制系统，采用双振动给料，进口仪表，技术先进，操作简便。
- 全不锈钢密封机体，具防腐防尘之功效。
- 计量斗能快速拆卸，便于清洗维修。
- 可应客户要求，进行不同分装形式组合，扩大秤量范围。
- 兼容性强，易与其他包装设备配合使用。

### (二) 适用范围

- 白糖、盐、种子、大米、味精、饲料、奶粉、咖啡、黄豆、芝麻等日用调味品等小颗粒状、粉状物料的定量称重。

### Features

- Adopt digital sensor to realize the accuracy measure in a moment.
- Microcomputer control system adopts double vibration infeeding, importing instrumentation technology and easy operation.
- Due to the sealed balance body with full stainless steel, it has dustproof and anticorrosive function.
- The measure hopper can be disassembled quickly, cleaned and repaired conveniently.
- Combine with all kinds of repacking form follow requirements of clients, to expand the scope of weighing.
- High compatibility, it is easy to combine with other packaging machine.

### Applications

- Suitable for packaging granulated and powder material such as white sugar, salt, seed, rice, monosodium glutamate, fodder, milk powder, coffee powder, soybean, soybean, sesame, daily appliance and so on.

### (三) 技术规格 Specifications

机 型 (Type)	LD-AX4-1	LD-AX4-2	LD-AX4-3
称重范围 (Weighing cap.(g))	5-300g	50-2000g	50-3000g
称量精度范围 (Accuracy)	0.5-1g	1-2g	1-3g
最大称量速度 (Max.Speed)	70wpm	50wpm	30wpm
料斗容量 (Hopper Volume)	500ml	3000ml	4500ml
参数预设数 (Control panel)	20		20
最多可称量物料 (Max Mixing products)	4		2
功 率 (Power)	1200w		1200w
电 源 (Power)	220v/50/60Hz/6A		220v/50/60Hz/6A
包装尺寸 (Packing dimension(mm))	(L)1028X(W)1078X(H)825		(L)1215X(W)1156X(H)1025

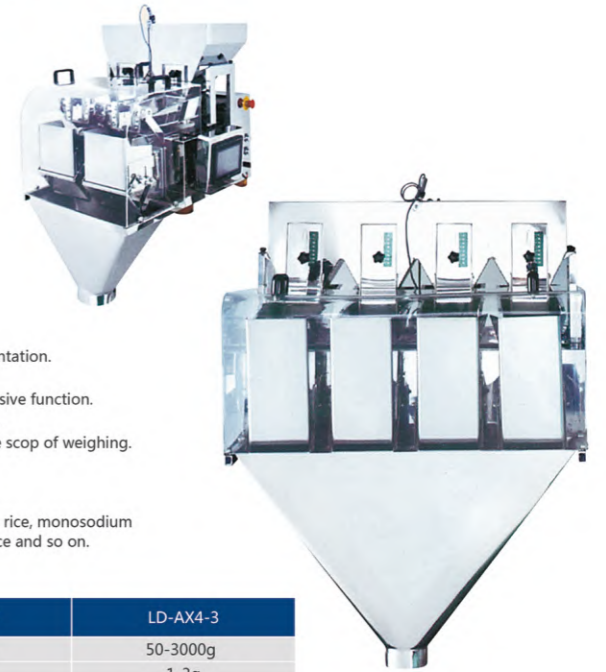

## 输送机系统

Conveyor series



Z型物料输送机 Z-Type Bucket Elevator

### 主要性能和结构特点

- 适合于输送易碎物料
- 采用国家级食品塑料，保障食品安全
- 性能稳定，噪音小
- 安装拆卸简单，方便清洗
- 规格可按客户要求定做
- 结构简单，价格便宜

### 适用范围

- 通过链条的传动，带动料斗提升，适用于粮食，食品，饲料和化工等部门的片状，块状的升运。

### Technical advantages

- Suitable to transport the materials which is easy crash.
- work stable low noise.
- Adopt the food safety class plastic, to ensure the food safety.
- Easy to washing.

### Application

Suitable to deliver sheet, massive material etc. Such as food, feed and chemical industry. Conveyor to work through the chain of transmission with large lifting quantity and high lifting height.



成品输送机 Finished product conveyor

### 主要性能和结构特点

- 线速度：18米/分钟
- 机架材质：机架采用304不锈钢，传动部分采用钢件表面处理浸镍或者发黑及铝型材，与食品接触部分采用食品级304不锈钢材质。

### Technical advantages

- Line speed: 18 m/min
- Finished product conveyor frame material: it is made of 304 stainless steel, and the transmission part is made of steel surface treated with nickel or black and aluminum profiles, the contact food part is made of food grade 304 stainless steel.